

B

C

E

公差表

REV	ECN NO	LOCATIONS	DESCRIPTION	DATE	CHANGER
A			新版本	2016-06-07	李国常

■ SPECIFICATIONS

- Voltage rating: 600V AC, DC
- Current rating: 1A, AC, DC
- Withstanding Voltage: 1800V AC/minute
- Insulation resistance: 1000MΩ min
- Temperature range: -40℃~+105℃
- Contact resistance: 10MΩ max

■ HOUSING

- Part No: H4001-NP
- Poles: 02-05
- Material: Nylon 66 UL94V-0

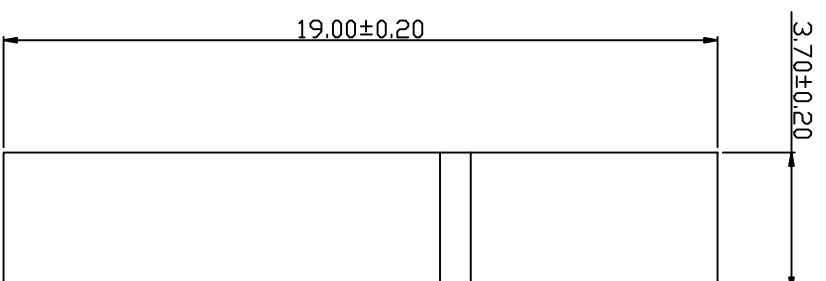
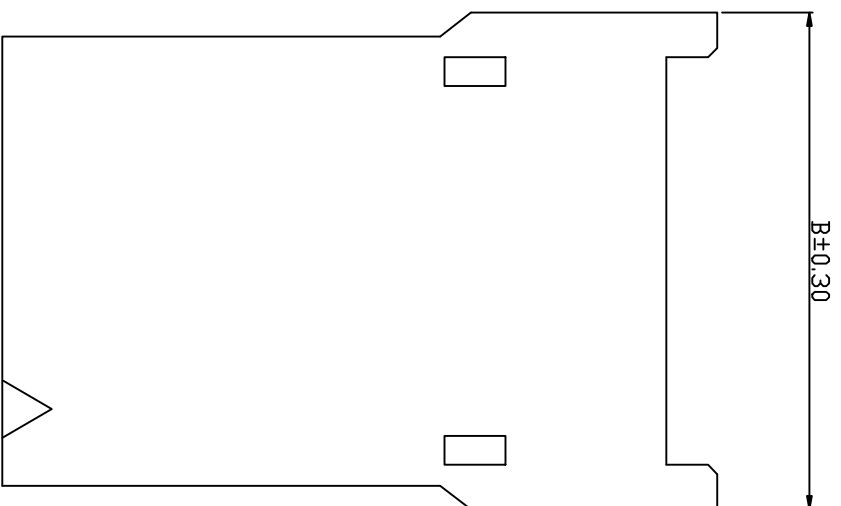

Part No	Dimensions (mm)	
	A	B
H4001-02	4.00	9.10
H4001-03	8.00	13.10
H4001-04	12.00	17.10
H4001-05	16.00	21.10

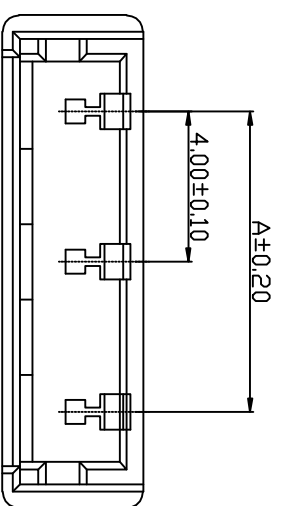

**KLT** 深圳市康利通电子科技有限公司

TITLE

成品规格图

TOLERANCE

0±0.30

.0±0.25

.00±0.20

CHECKED BY

DATE

SCALE

.000±0.015

DRAWN BY

2016-06-07

1:1

VER No SIZE

UNIT:mm

PART No



A A4

李国常

H4001-NP

H4001-NP

4

4

B

C

D

E

F

1

B

C

E

公差表

REV	ECN NO	LOCATIONS	DESCRIPTION	DATE	CHANGER
A			新版本	2016-06-07	李国常

**SPECIFICATIONS**

- Voltage rating: 600V AC, DC
- Current rating: 1A, AC, DC
- Withstanding Voltage: 1800V AC/minute
- Insulation resistance: 1000MΩ min
- Temperature range: -40℃~+105℃
- Contact resistance: 10MΩ max

**HOUSING**

- Part No: H4002-NP
- Poles: 02-05
- Material: Nylon 66 UL94V-0

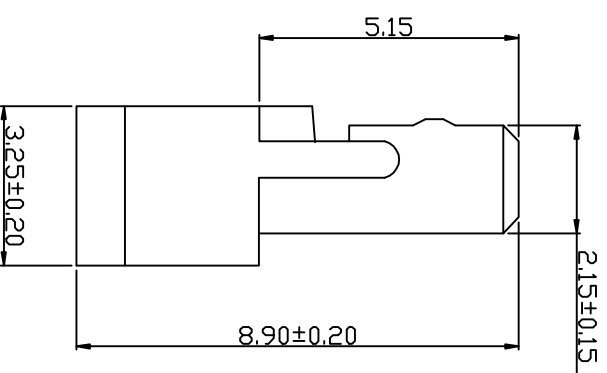
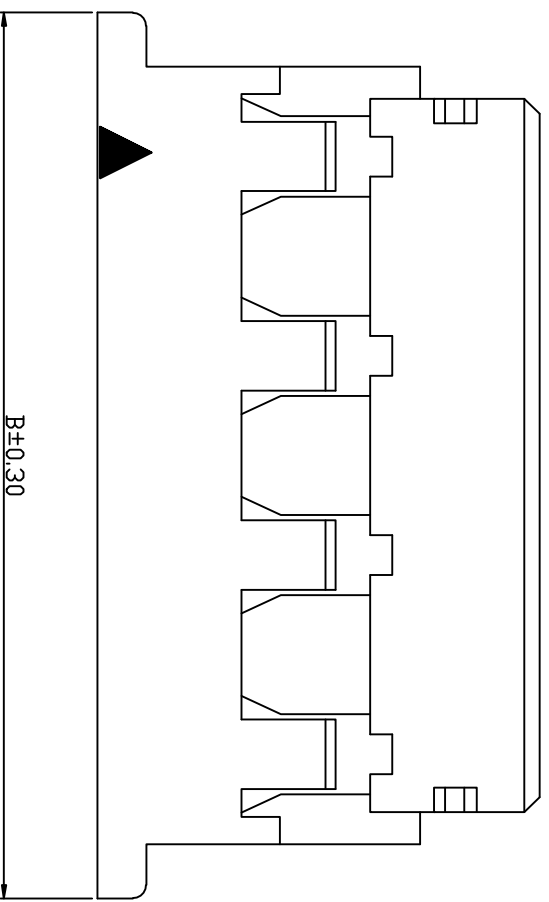

Part No	Dimensions (mm)	
	A	B
H4002-02	4.00	9.80
H4002-03	8.00	13.80
H4002-04	12.00	17.80
H4002-05	16.00	21.80

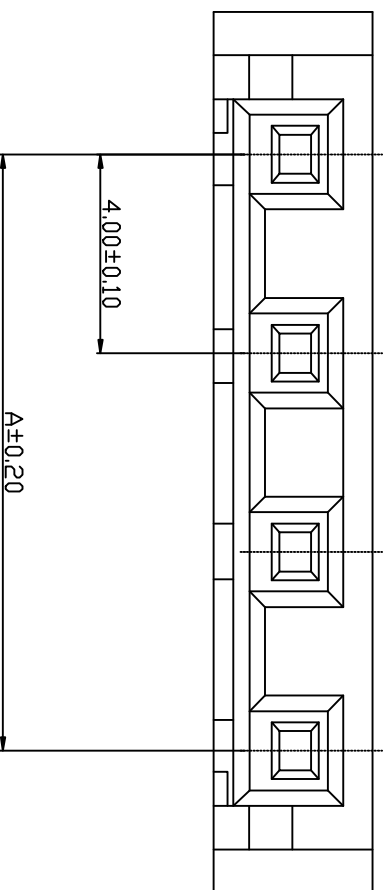

**KLT** 深圳市康利通电子科技有限公司

成品规格图

TOLERANCE

0±0.30

.0±0.25

.00±0.20

.000±0.015

VER No SIZE

A A4

TITLE	成品规格图		TOLERANCE	
CHECKED BY	DATE	SCALE	VER No	SIZE
DRAWN BY	UNIT:mm	1:1	A	A4
李国常	2016-06-07			
PART No	H4002-NP			

4

4

B

C

D

E

F

1

B

C

E

公差表

REV	ECN NO	LOCATIONS	DESCRIPTION	DATE	CHANGER
A			新版本	2016-06-07	李国常

4

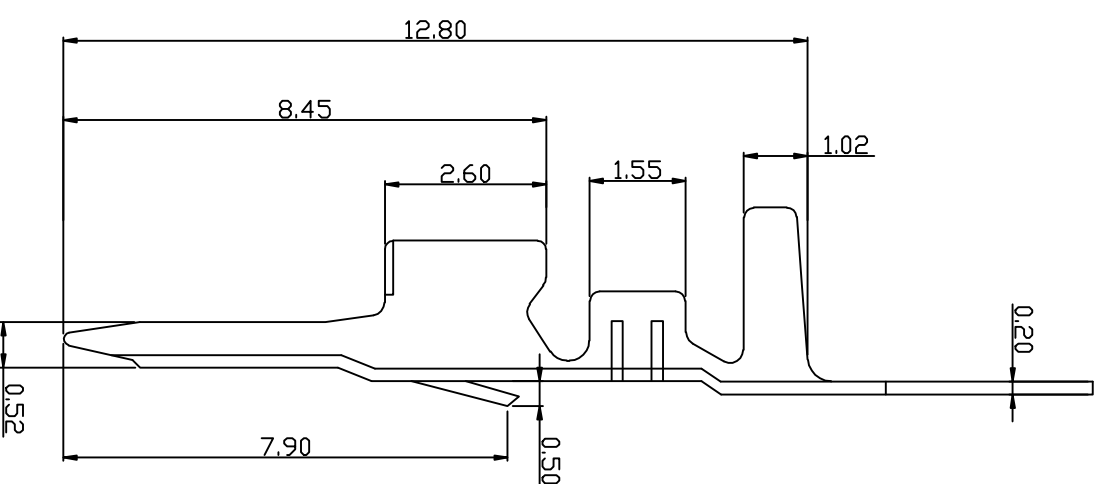
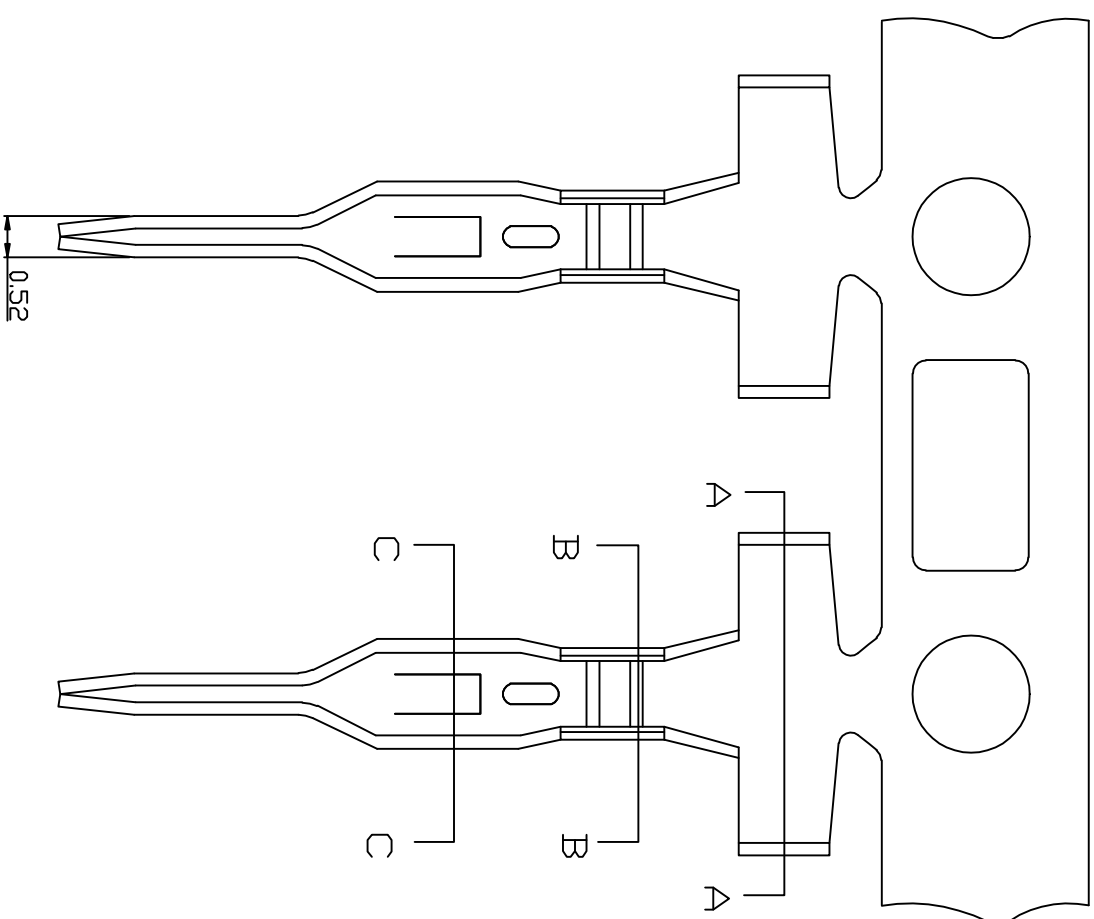

- SPECIFICATIONS**
- Voltage rating: 250V AC, DC
  - Current rating: 7A, AC, DC
  - Withstanding Voltage: 1500V AC/minute
  - Insulation resistance: 1000MΩ min
  - Temperature range: -40℃~+85℃
  - Contact resistance: 10MΩ max
- TERMINAL**
- Part No: T4001PT
  - Applicable wire: AWG#22-#28
  - Material: Phosphor Bronze
  - Finish: Tin plated

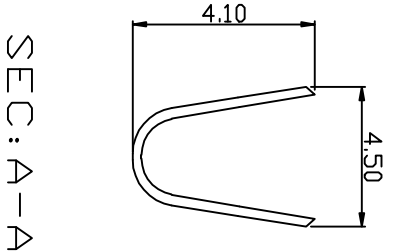

SEC: A-A

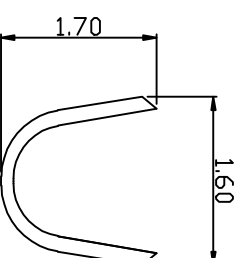

SEC: B-B

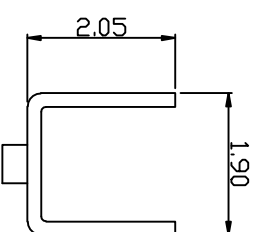

SEC: C-C

**KLIT** 深圳市康利通电子科技有限公司

TITLE

成品规格图

TO CERANCE

0±0.30

.0±0.25

.00±0.20

.000±0.015

CHECKED BY

DATE

SCALE

2016-06-07

1:1

VER No

SIZE

DRAWN BY

UNIT:mm



A

A4

李国常

PART No

T4001PT

B

C

D

E

F

1

4

B

C

E

公差表

REV	ECN NO	LOCATIONS	DESCRIPTION	DATE	CHANGER
A			新版本	2016-06-07	李国常

4

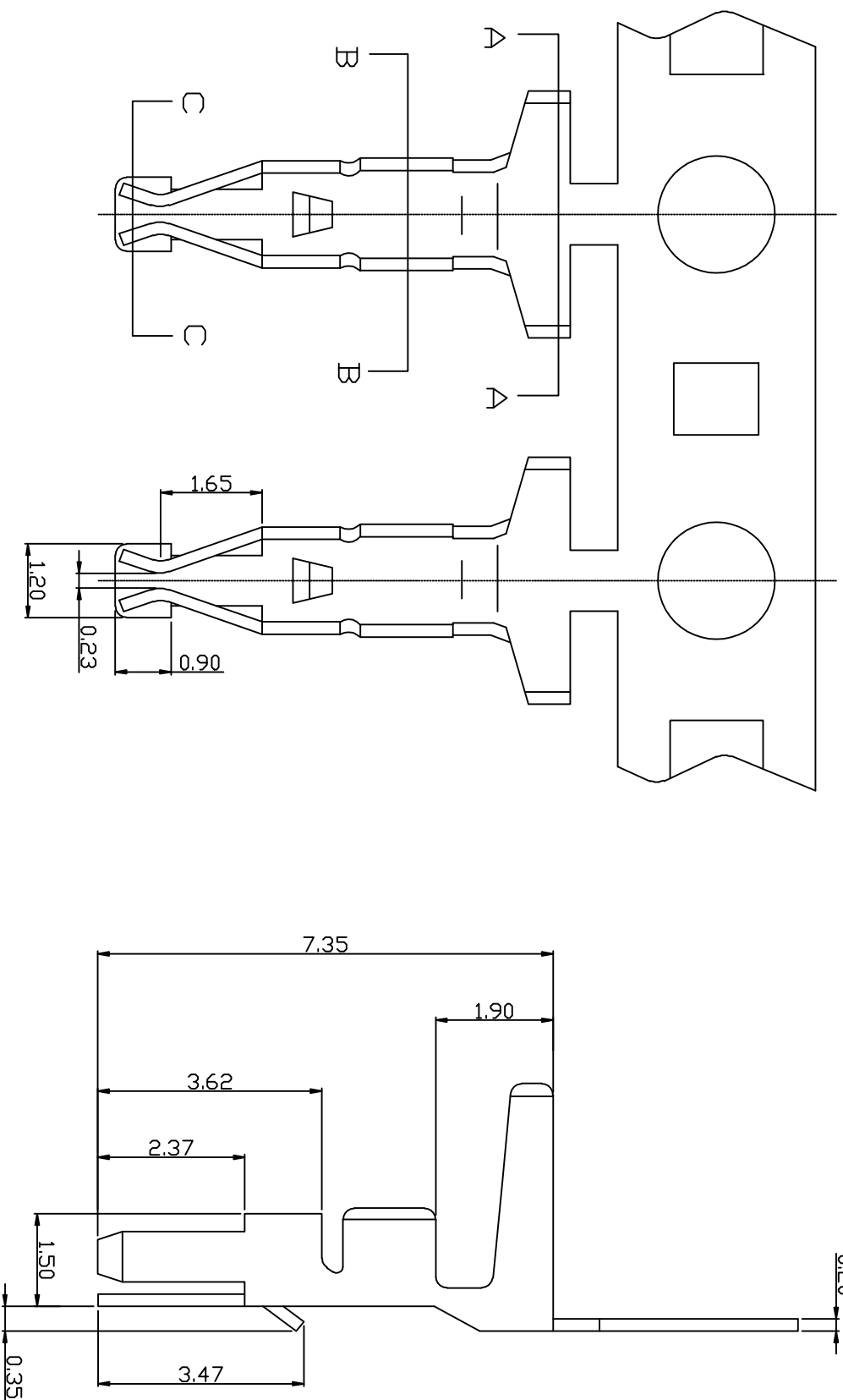

- SPECIFICATIONS**
- Voltage rating: 250V AC, DC
  - Current rating: 7A, AC, DC
  - Withstanding Voltage: 1500V AC/minute
  - Insulation resistance: 1000MΩ min
  - Temperature range: -40℃~+85℃
  - Contact resistance: 10MΩ max
- TERMINAL**
- Part No: T4002PT
  - Applicable wire: AWG#22-#28
  - Material: Phosphor Bronze
  - Finish: Tin plated

4

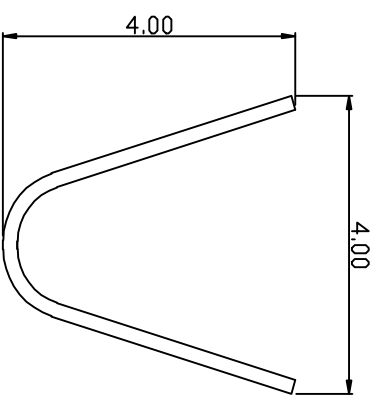

SEC: A-A

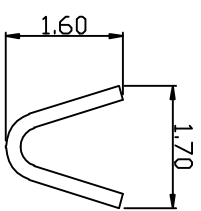

SEC: B-B

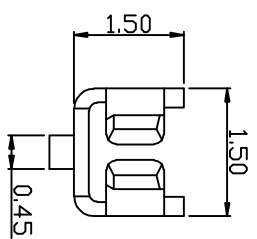

SEC: C-C

**KLT** 深圳市康利通电子科技有限公司

成品规格图

Tolerance

0±0.30

.0±0.25

.00±0.20

.000±0.015

1

TITLE	DATE	SCALE	VER No	SIZE
CHECKED BY	2016-06-07	1:1	A	A4
DRAWN BY	UNIT:mm			
李国常	PART No	T4002PT		

B

C

D

E

F

B

C

E

公差表

REV	ECN NO	LOCATIONS	DESCRIPTION	DATE	CHANGER
A			新版本	2016-06-07	李国常

**SPECIFICATIONS**

- Voltage rating: 600V AC, DC
  - Current rating: 1A, AC, DC
  - Withstanding Voltage: 1500V AC/minute
  - Insulation resistance: 1000MΩ min
  - Temperature range: -40℃~+85℃
  - Contact resistance: 10MΩ max
- WAFER**
- Part No: W4001R-NP
  - Poles: 03-09
  - Material: Nylon 6T UL94V-0
  - Pin Material: Brass /Tin-plated

4

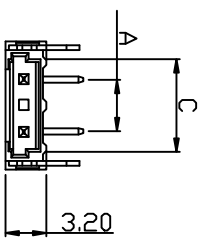

W4001R-03N01

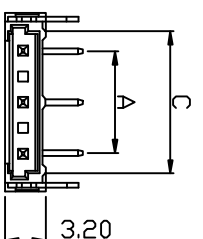

W4001R-05N02

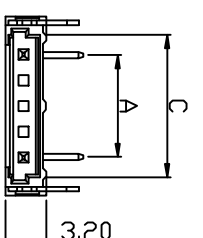

W4001R-05N03

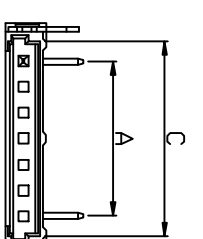

W4001R-07N05

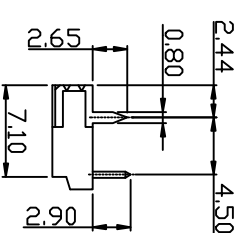
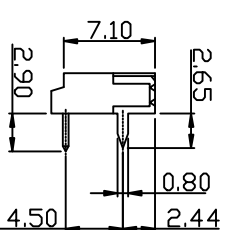

Part No	Dimensions (mm)		
	A	B	C
W4001R-03N01	4.00	10.00	6.80
W4001R-05N02	8.00	14.00	10.80
W4001R-05N03	8.00	14.00	10.80
W4001R-07N05	12.00	18.00	14.80
W4001R-07N04L	12.00	18.00	14.80
W4001R-07N04	12.00	18.00	14.80
W4001R-07N03	12.00	18.00	14.80
W4001R-09N04	16.00	22.00	18.80

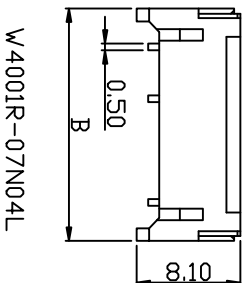

W4001R-07N04L

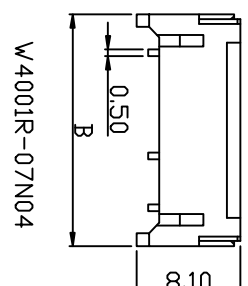

W4001R-07N04

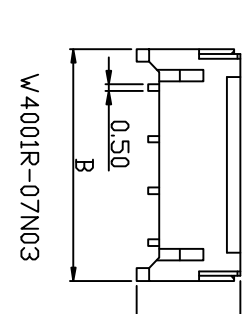

W4001R-07N03

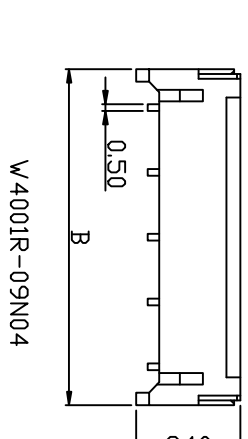

W4001R-09N04



深圳市康利通电子科技有限公司

TOCERANCE

0±0.30

.0±0.25

.00±0.20

.000±0.015

P.C.B LAYOUT

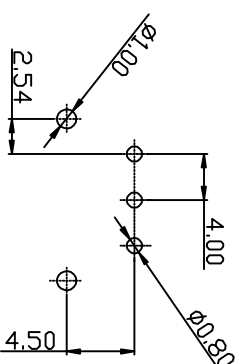

成品规格图

TITLE	DATE	SCALE	VER No	SIZE
CHECKED BY	2016-06-07	1:1	A	A4

DRAWN BY	UNIT:mm		
李国常			

PART No	W4001R-NP
---------	-----------

B

C

D

E

F

1

4

B

C

E

公差表

REV	ECN NO	LOCATIONS	DESCRIPTION	DATE	CHANGER
A			新版本	2016-06-07	李国常

**SPECIFICATIONS**

- Voltage rating: 600V AC, DC
  - Current rating: 1A, AC, DC
  - Withstanding Voltage: 1500V AC/minute
  - Insulation resistance: 1000MΩ min
  - Temperature range: -40℃~+85℃
  - Contact resistance: 10MΩ max
- WAFER**
- Part No: W4001SR-NP
  - Poles: 03-09
  - Material: Nylon 6T UL94V-0
  - Pin Material: Brass /Tin-plated

4

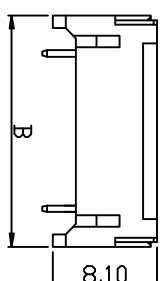
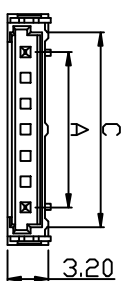
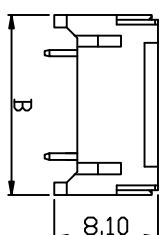
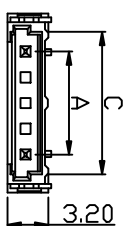
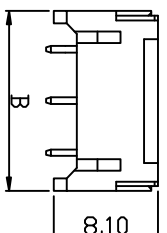
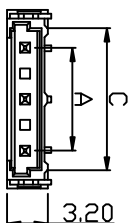
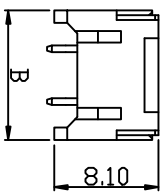
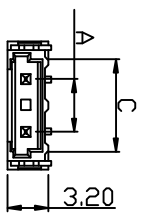

W4001SR-03N01

W4001SR-05N02

W4001SR-05N03

W4001SR-07N05

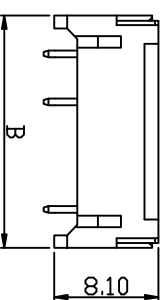
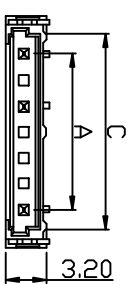
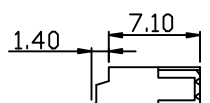

W4001SR-07N04L

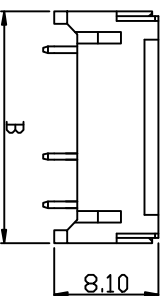
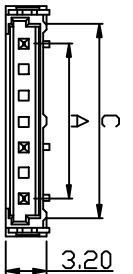

W4001SR-07N04

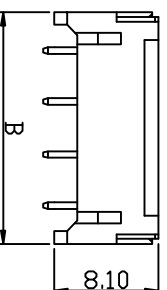
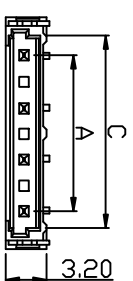

W4001SR-07N03

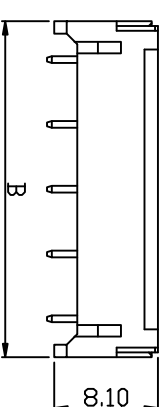
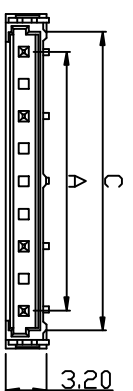

W4001SR-09N04

Part No	Dimensions (mm)		
	A	B	C
W4001SR-03N01	4.00	10.00	6.80
W4001SR-05N02	8.00	14.00	10.80
W4001SR-05N03	8.00	14.00	10.80
W4001SR-07N05	12.00	18.00	14.80
W4001SR-07N04L	12.00	18.00	14.80
W4001SR-07N04	12.00	18.00	14.80
W4001SR-07N03	12.00	18.00	14.80
W4001SR-09N04	16.00	22.00	18.80

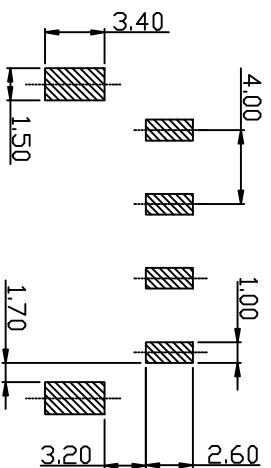

P.C.B LAYOUT



深圳市康利通电子科技有限公司

TOCERANCE

0±0.30

.0±0.25

.00±0.20

.000±0.015

1

成品规格图

0±0.30

TITLE	DATE	SCALE	VER No	SIZE
CHECKED BY	2016-06-07	1:1	A	A4

DRAWN BY	UNIT:mm	Part No	W4001SR-NP
李国常			

B

C

D

E

F

4