

B

C

E

公差表

| REV | ECN NO | LOCATIONS | DESCRIPTION | DATE       | CHANGER |
|-----|--------|-----------|-------------|------------|---------|
| A   |        |           | 新版本         | 2016-05-24 | 李国常     |

4

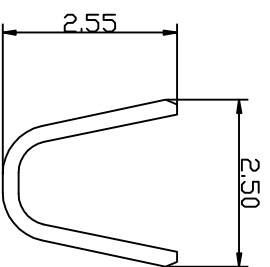
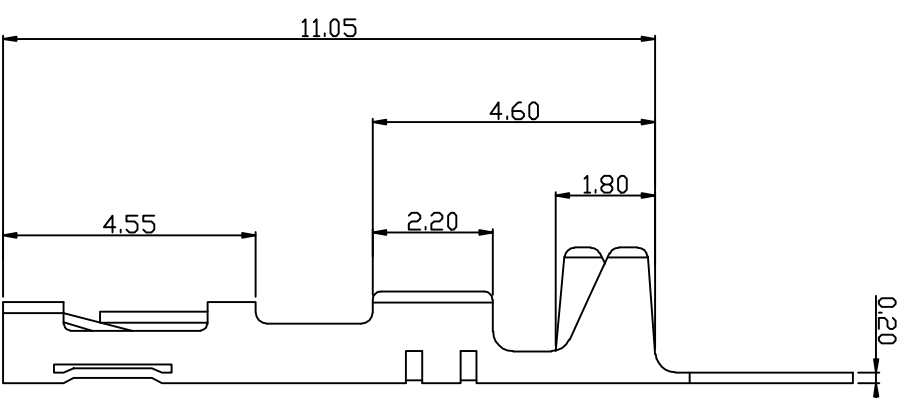
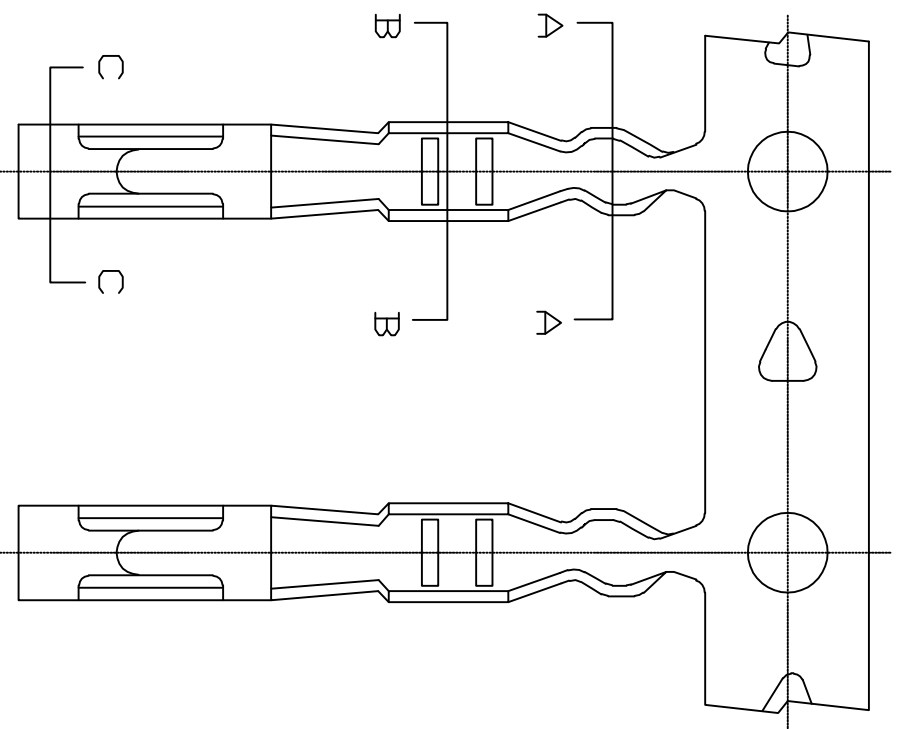

SEC: A-A

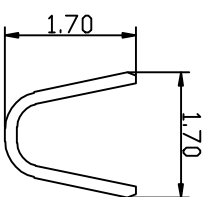

SEC: B-B

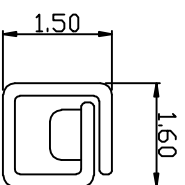

SEC: C-C

**KLT** 深圳市康利通电子科技有限公司

成品规格图

TOLERANCE

0±0.30

.0±0.25

.00±0.20

.000±0.015

1

| TITLE      | DATE       | SCALE   | VER No | SIZE |
|------------|------------|---------|--------|------|
| CHECKED BY | 2016-05-24 | 1:1     |        |      |
| DRAWN BY   | UNIT:mm    |         | A      | A4   |
| 李国常        | PART No    | T2544PG |        |      |

B

C

D

E

F

4

B

C

E

公差表

| REV | ECN NO | LOCATIONS | DESCRIPTION | DATE       | CHANGER |
|-----|--------|-----------|-------------|------------|---------|
| A   |        |           | 新版本         | 2016-05-24 | 李国常     |

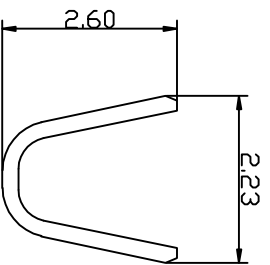
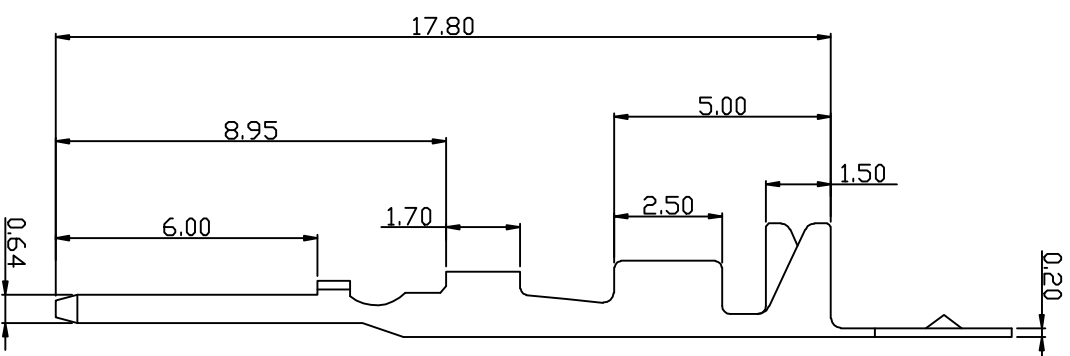
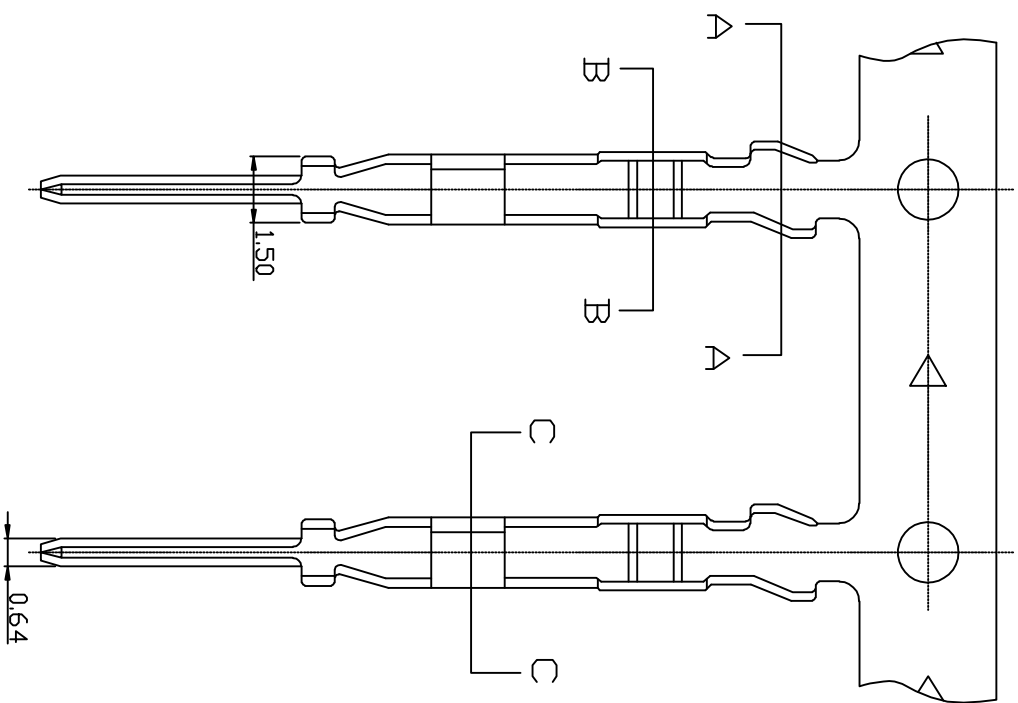

SEC: A-A

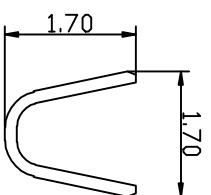

SEC: B-B

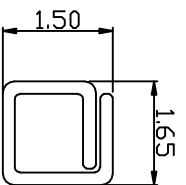

SEC: C-C

- SPECIFICATIONS**
- Voltage rating: 250V AC, DC
  - Current rating: 3A, AC, DC
  - Withstanding Voltage: 1000V AC/minute
  - Insulation resistance: 1000MΩ min
  - Temperature range: -40℃~+85℃
  - Contact resistance: 10MΩ max
- TERMINAL**
- Part No: T2544MBT
  - Applicable wire: AWG#22-#26
  - Material: Brass
  - Finish: Tin plated

**KLT** 深圳市康利通电子科技有限公司

成品规格图

TOLERANCE

0±0.30

.0±0.25

.00±0.20

.000±0.015

1

| TITLE      | DATE       | SCALE | VER No | SIZE |
|------------|------------|-------|--------|------|
| CHECKED BY | 2016-05-24 | 1:1   |        |      |
| DRAWN BY   | UNIT:mm    |       | A      | A4   |
| PART No    | T2544MBT   |       |        |      |

李国常

PART No

T2544MBT

B

C

D

E

F

4

4

B

C

E

公差表

| REV | ECN NO | LOCATIONS | DESCRIPTION | DATE       | CHANGER |
|-----|--------|-----------|-------------|------------|---------|
| A   |        |           | 新版本         | 2016-05-24 | 李国常     |

4

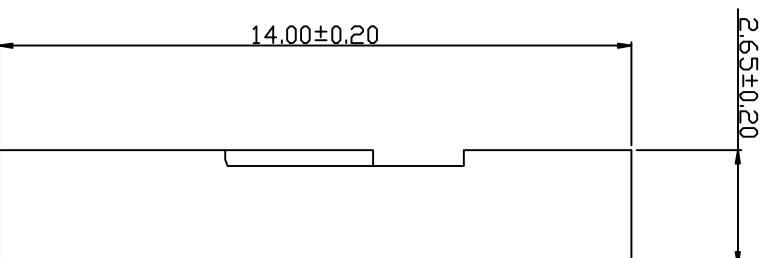
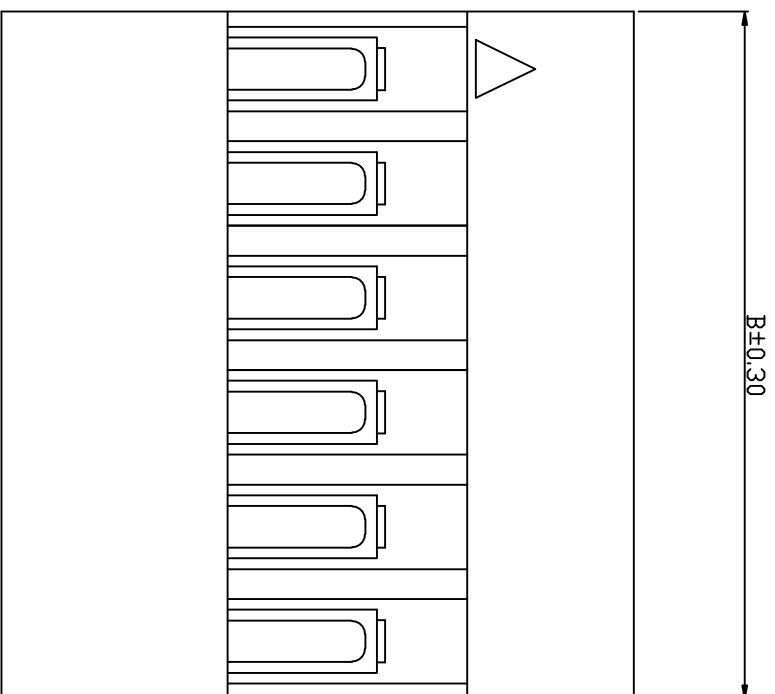

4

- SPECIFICATIONS**
- Voltage rating: 250V AC, DC
  - Current rating: 3A, AC, DC
  - Withstanding Voltage: 1500V AC/minute
  - Insulation resistance: 1000MΩ min
  - Temperature range: -40℃~+85℃
  - Contact resistance: 20MΩ max
- HOUSING**
- Part No: H2544-NP
  - Poles: 01-40
  - Material: PBT UL94V-0

| Part No  | Dimensions (mm) |       |
|----------|-----------------|-------|
|          | A               | B     |
| H2544-01 | —               | 2.54  |
| H2544-02 | 2.54            | 5.08  |
| H2544-03 | 5.08            | 7.62  |
| H2544-04 | 7.62            | 10.16 |
| H2544-05 | 10.16           | 12.70 |
| H2544-06 | 12.70           | 15.24 |
| H2544-07 | 15.24           | 17.78 |
| H2544-08 | 17.78           | 20.32 |
| H2544-09 | 20.32           | 22.86 |
| H2544-10 | 22.86           | 25.40 |
| H2544-11 | 25.40           | 27.94 |
| H2544-12 | 27.94           | 30.48 |
| H2544-13 | 30.48           | 33.02 |
| H2544-14 | 33.02           | 35.56 |
| H2544-15 | 35.56           | 38.10 |
| H2544-16 | 38.10           | 40.64 |
| H2544-17 | 40.64           | 43.18 |
| H2544-18 | 43.18           | 45.72 |
| H2544-19 | 45.72           | 48.26 |
| H2544-20 | 48.26           | 50.80 |

| Part No  | Dimensions (mm) |        |
|----------|-----------------|--------|
|          | A               | B      |
| H2544-21 | 50.80           | 53.34  |
| H2544-22 | 53.34           | 55.88  |
| H2544-23 | 55.88           | 58.42  |
| H2544-24 | 58.42           | 60.96  |
| H2544-25 | 60.96           | 63.50  |
| H2544-26 | 63.50           | 66.04  |
| H2544-27 | 66.04           | 68.58  |
| H2544-28 | 68.58           | 71.12  |
| H2544-29 | 71.12           | 73.66  |
| H2544-30 | 73.66           | 76.20  |
| H2544-31 | 76.20           | 78.74  |
| H2544-32 | 78.74           | 81.28  |
| H2544-33 | 81.28           | 83.82  |
| H2544-34 | 83.82           | 86.36  |
| H2544-35 | 86.36           | 88.90  |
| H2544-36 | 88.90           | 91.44  |
| H2544-37 | 91.44           | 93.98  |
| H2544-38 | 93.98           | 96.52  |
| H2544-39 | 96.52           | 99.06  |
| H2544-40 | 99.06           | 101.60 |

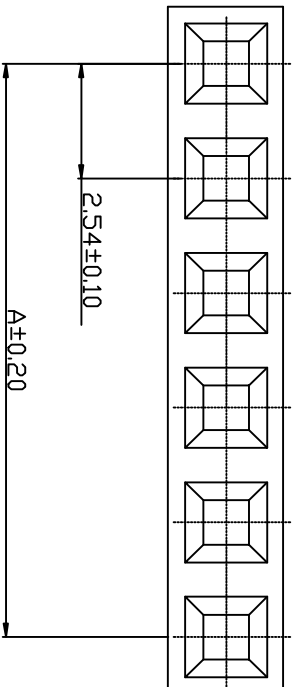

**KLIT** 深圳市康利通电子科技有限公司

TOCERANCE

0±0.30

.0±0.25

.00±0.20

.000±0.015

1

成品规格图

| TITLE      | 成品规格图   |        |
|------------|---------|--------|
| CHECKED BY | DATE    | SCALE  |
| DRAWN BY   | UNIT:mm | VER No |
| PART No    | PART No | SIZE   |

|     |            |     |   |    |
|-----|------------|-----|---|----|
| 李国常 | 2016-05-24 | 1:1 | A | A4 |
| 李国常 | H2544-NP   |     |   |    |

B

C

D

E

F

B

C

E

公差表

| REV | ECN NO | LOCATIONS | DESCRIPTION | DATE       | CHANGER |
|-----|--------|-----------|-------------|------------|---------|
| A   |        |           | 新版本         | 2016-05-24 | 李国常     |

■ SPECIFICATIONS

- Voltage rating: 250V AC, DC
- Current rating: 3A, AC, DC
- Withstanding Voltage: 1500V AC/minute
- Insulation resistance: 1000MΩ min
- Temperature range: -40℃~+85℃
- Contact resistance: 20MΩ max

■ HOUSING

- Part No: H2544T-NP
- Poles: 01-40
- Material: PBT UL94V-0

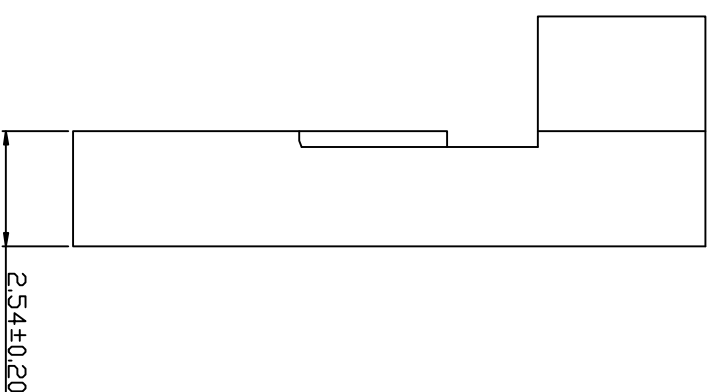
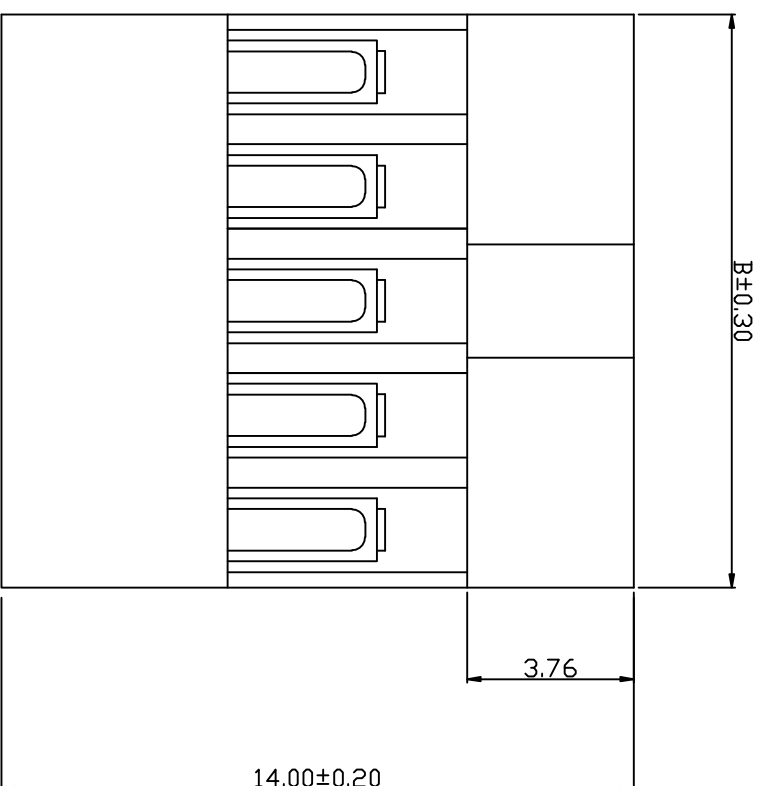

| Part No   | Dimensions (mm) |       |
|-----------|-----------------|-------|
|           | A               | B     |
| H2544T-01 | —               | 2.54  |
| H2544T-02 | 2.54            | 5.08  |
| H2544T-03 | 5.08            | 7.62  |
| H2544T-04 | 7.62            | 10.16 |
| H2544T-05 | 10.16           | 12.70 |
| H2544T-06 | 12.70           | 15.24 |
| H2544T-07 | 15.24           | 17.78 |
| H2544T-08 | 17.78           | 20.32 |
| H2544T-09 | 20.32           | 22.86 |
| H2544T-10 | 22.86           | 25.40 |
| H2544T-11 | 25.40           | 27.94 |
| H2544T-12 | 27.94           | 30.48 |
| H2544T-13 | 30.48           | 33.02 |
| H2544T-14 | 33.02           | 35.56 |
| H2544T-15 | 35.56           | 38.10 |
| H2544T-16 | 38.10           | 40.64 |
| H2544T-17 | 40.64           | 43.18 |
| H2544T-18 | 43.18           | 45.72 |
| H2544T-19 | 45.72           | 48.26 |
| H2544T-20 | 48.26           | 50.80 |

| Part No   | Dimensions (mm) |        |
|-----------|-----------------|--------|
|           | A               | B      |
| H2544T-21 | 50.80           | 53.34  |
| H2544T-22 | 53.34           | 55.88  |
| H2544T-23 | 55.88           | 58.42  |
| H2544T-24 | 58.42           | 60.96  |
| H2544T-25 | 60.96           | 63.50  |
| H2544T-26 | 63.50           | 66.04  |
| H2544T-27 | 66.04           | 68.58  |
| H2544T-28 | 68.58           | 71.12  |
| H2544T-29 | 71.12           | 73.66  |
| H2544T-30 | 73.66           | 76.20  |
| H2544T-31 | 76.20           | 78.74  |
| H2544T-32 | 78.74           | 81.28  |
| H2544T-33 | 81.28           | 83.82  |
| H2544T-34 | 83.82           | 86.36  |
| H2544T-35 | 86.36           | 88.90  |
| H2544T-36 | 88.90           | 91.44  |
| H2544T-37 | 91.44           | 93.98  |
| H2544T-38 | 93.98           | 96.52  |
| H2544T-39 | 96.52           | 99.06  |
| H2544T-40 | 99.06           | 101.60 |

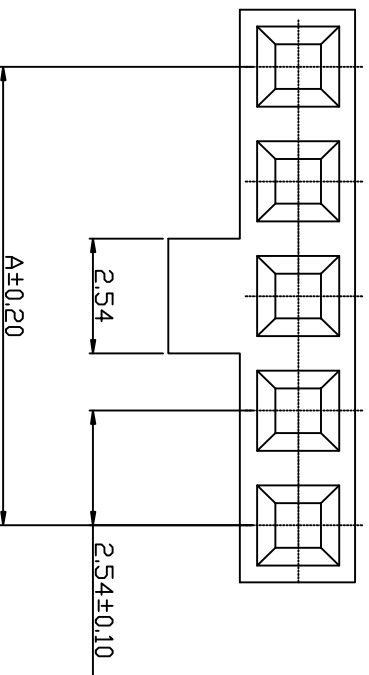

**KLT** 深圳市康利通电子科技有限公司

TITLE 成品规格图

CHECKED BY DATE SCALE

DRAWN BY UNIT:mm 1:1

PART No H2544T-NP

TOLERANCE

0±0.30

.0±0.25

.00±0.20

.000±0.015

VER No SIZE

A A4

4

4

B

C

D

E

F

1

B

C

E

公差表

| REV | ECN NO | LOCATIONS | DESCRIPTION | DATE       | CHANGER |
|-----|--------|-----------|-------------|------------|---------|
| A   |        |           | 新版本         | 2016-05-24 | 李国常     |

4

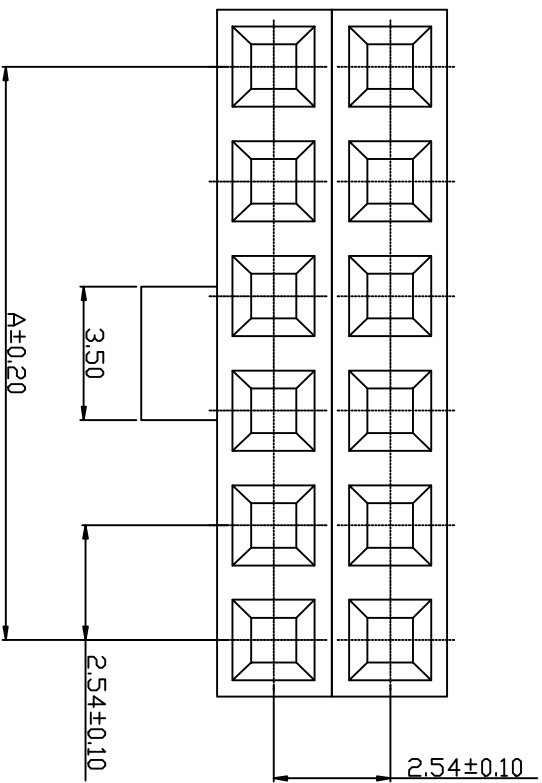
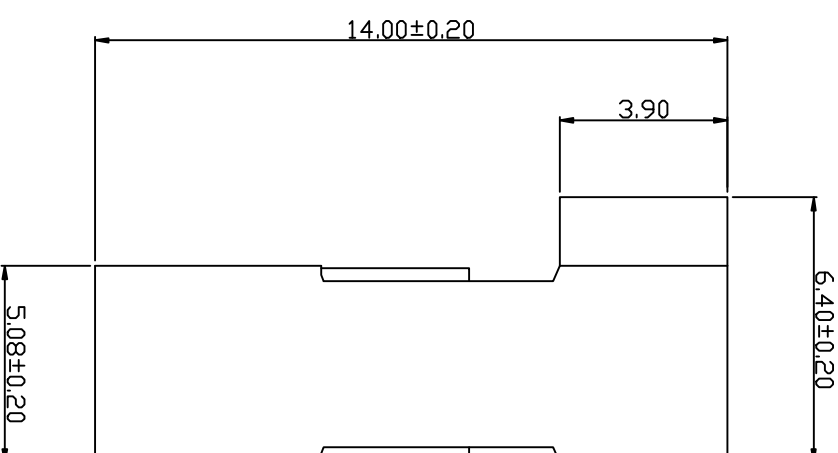
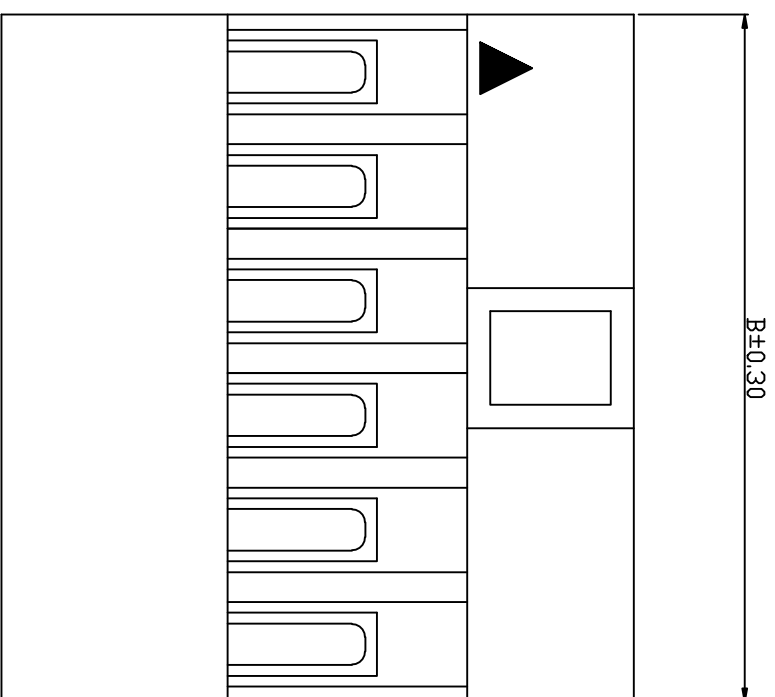

- SPECIFICATIONS**
- Voltage rating: 250V AC, DC
  - Current rating: 3A, AC, DC
  - Withstanding Voltage: 1500V AC/minute
  - Insulation resistance: 1000MΩ min
  - Temperature range: -40℃~+85℃
  - Contact resistance: 20MΩ max
- HOUSING**
- Part No: H2544T-2\*NP
  - Poles: 04-80
  - Material: PBT UL94V-0

| Part No     | Dimensions (mm) |       |
|-------------|-----------------|-------|
|             | A               | B     |
| H2544T-2*02 | 2.54            | 5.08  |
| H2544T-2*03 | 5.08            | 7.62  |
| H2544T-2*04 | 7.62            | 10.16 |
| H2544T-2*05 | 10.16           | 12.70 |
| H2544T-2*06 | 12.70           | 15.24 |
| H2544T-2*07 | 15.24           | 17.78 |
| H2544T-2*08 | 17.78           | 20.32 |
| H2544T-2*09 | 20.32           | 22.86 |
| H2544T-2*10 | 22.86           | 25.40 |
| H2544T-2*11 | 25.40           | 27.94 |
| H2544T-2*12 | 27.94           | 30.48 |
| H2544T-2*13 | 30.48           | 33.02 |
| H2544T-2*14 | 33.02           | 35.56 |
| H2544T-2*15 | 35.56           | 38.10 |
| H2544T-2*16 | 38.10           | 40.64 |
| H2544T-2*17 | 40.64           | 43.18 |
| H2544T-2*18 | 43.18           | 45.72 |
| H2544T-2*19 | 45.72           | 48.26 |
| H2544T-2*20 | 48.26           | 50.80 |

| Part No     | Dimensions (mm) |        |
|-------------|-----------------|--------|
|             | A               | B      |
| H2544T-2*21 | 50.80           | 53.34  |
| H2544T-2*22 | 53.34           | 55.88  |
| H2544T-2*23 | 55.88           | 58.42  |
| H2544T-2*24 | 58.42           | 60.96  |
| H2544T-2*25 | 60.96           | 63.50  |
| H2544T-2*26 | 63.50           | 66.04  |
| H2544T-2*27 | 66.04           | 68.58  |
| H2544T-2*28 | 68.58           | 71.12  |
| H2544T-2*29 | 71.12           | 73.66  |
| H2544T-2*30 | 73.66           | 76.20  |
| H2544T-2*31 | 76.20           | 78.74  |
| H2544T-2*32 | 78.74           | 81.28  |
| H2544T-2*33 | 81.28           | 83.82  |
| H2544T-2*34 | 83.82           | 86.36  |
| H2544T-2*35 | 86.36           | 88.90  |
| H2544T-2*36 | 88.90           | 91.44  |
| H2544T-2*37 | 91.44           | 93.98  |
| H2544T-2*38 | 93.98           | 96.52  |
| H2544T-2*39 | 96.52           | 99.06  |
| H2544T-2*40 | 99.06           | 101.60 |

4

**KLT** 深圳市康利通电子科技有限公司

TOLERANCE

0±0.30

.0±0.25

.00±0.20

.000±0.015

|            |         |             |
|------------|---------|-------------|
| TITLE      | 成品规格图   |             |
| CHECKED BY | DATE    | SCALE       |
| 2016-05-24 | 1:1     |             |
| DRAWN BY   | UNIT:mm |             |
| 李国常        | PART No | H2544T-2*NP |

1

B

C

D

E

F

B

C

E

公差表

| REV | ECN NO | LOCATIONS | DESCRIPTION | DATE       | CHANGER |
|-----|--------|-----------|-------------|------------|---------|
| A   |        |           | 新版本         | 2016-05-24 | 李国常     |

■ SPECIFICATIONS

- Voltage rating: 250V AC, DC
- Current rating: 3A, AC, DC
- Withstanding Voltage: 1500V AC/minute
- Insulation resistance: 1000MΩ min
- Temperature range: -40℃~+85℃
- Contact resistance: 20MΩ max

■ HOUSING

- Part No: H2544-2\*NP
- Poles: 04-80
- Material: PBT UL94V-0

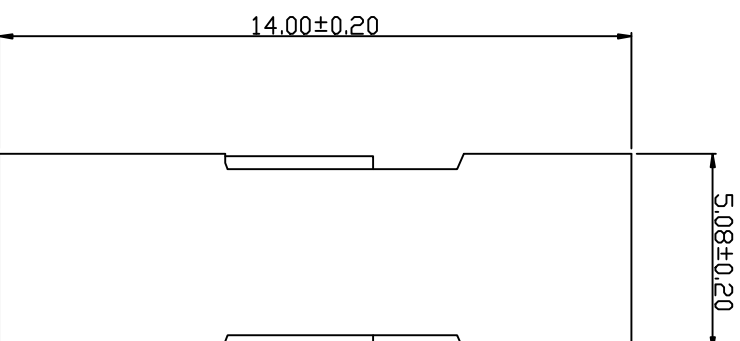
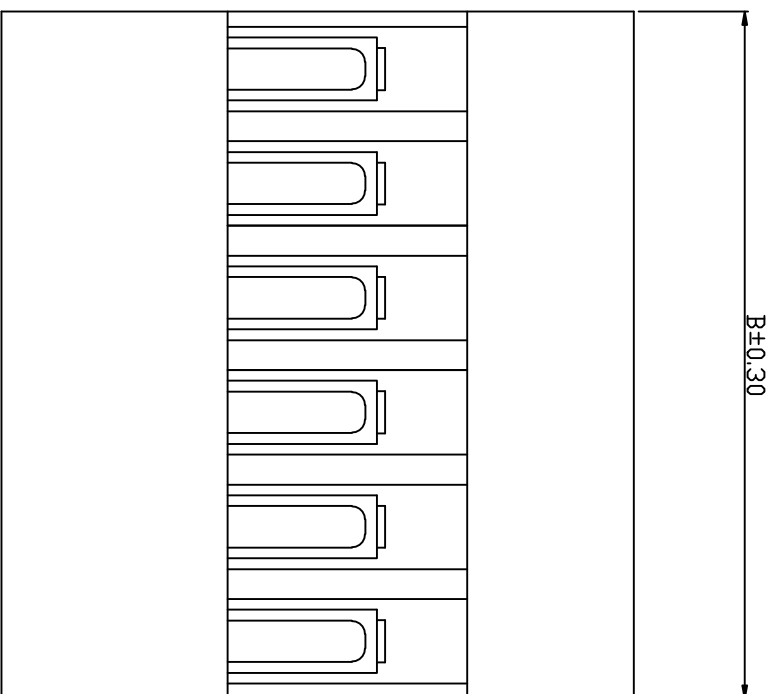

| Part No    | Dimensions (mm) |       |
|------------|-----------------|-------|
|            | A               | B     |
| H2544-2*02 | 2.54            | 5.08  |
| H2544-2*03 | 5.08            | 7.62  |
| H2544-2*04 | 7.62            | 10.16 |
| H2544-2*05 | 10.16           | 12.70 |
| H2544-2*06 | 12.70           | 15.24 |
| H2544-2*07 | 15.24           | 17.78 |
| H2544-2*08 | 17.78           | 20.32 |
| H2544-2*09 | 20.32           | 22.86 |
| H2544-2*10 | 22.86           | 25.40 |
| H2544-2*11 | 25.40           | 27.94 |
| H2544-2*12 | 27.94           | 30.48 |
| H2544-2*13 | 30.48           | 33.02 |
| H2544-2*14 | 33.02           | 35.56 |
| H2544-2*15 | 35.56           | 38.10 |
| H2544-2*16 | 38.10           | 40.64 |
| H2544-2*17 | 40.64           | 43.18 |
| H2544-2*18 | 43.18           | 45.72 |
| H2544-2*19 | 45.72           | 48.26 |
| H2544-2*20 | 48.26           | 50.80 |

| Part No    | Dimensions (mm) |        |
|------------|-----------------|--------|
|            | A               | B      |
| H2544-2*21 | 50.80           | 53.34  |
| H2544-2*22 | 53.34           | 55.88  |
| H2544-2*23 | 55.88           | 58.42  |
| H2544-2*24 | 58.42           | 60.96  |
| H2544-2*25 | 60.96           | 63.50  |
| H2544-2*26 | 63.50           | 66.04  |
| H2544-2*27 | 66.04           | 68.58  |
| H2544-2*28 | 68.58           | 71.12  |
| H2544-2*29 | 71.12           | 73.66  |
| H2544-2*30 | 73.66           | 76.20  |
| H2544-2*31 | 76.20           | 78.74  |
| H2544-2*32 | 78.74           | 81.28  |
| H2544-2*33 | 81.28           | 83.82  |
| H2544-2*34 | 83.82           | 86.36  |
| H2544-2*35 | 86.36           | 88.90  |
| H2544-2*36 | 88.90           | 91.44  |
| H2544-2*37 | 91.44           | 93.98  |
| H2544-2*38 | 93.98           | 96.52  |
| H2544-2*39 | 96.52           | 99.06  |
| H2544-2*40 | 99.06           | 101.60 |

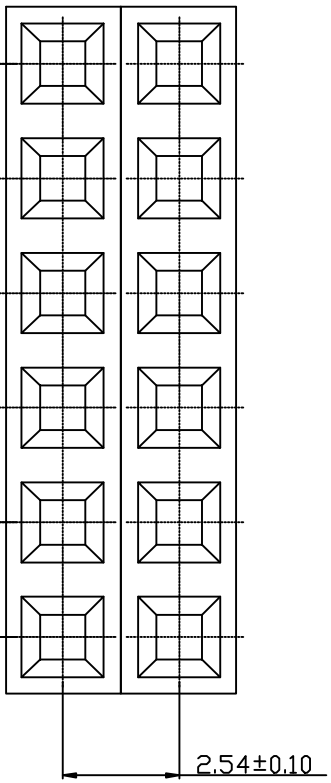

4

4

**KLT** 深圳市康利通电子科技有限公司

TOLERANCE

0±0.30

.0±0.25

.00±0.20

.000±0.015

|            |         |            |
|------------|---------|------------|
| TITLE      | 成品规格图   |            |
| CHECKED BY | DATE    | SCALE      |
| 2016-05-24 | 1:1     |            |
| DRAWN BY   | UNIT:mm |            |
| 李国常        | PART No | H2544-2*NP |
|            | VER No  | SIZE       |
|            | A       | A4         |

B

C

D

E

F

1

B

C

E

公差表

| REV | ECN NO | LOCATIONS | DESCRIPTION | DATE       | CHANGER |
|-----|--------|-----------|-------------|------------|---------|
| A   |        |           | 新版本         | 2016-05-24 | 李国常     |

4

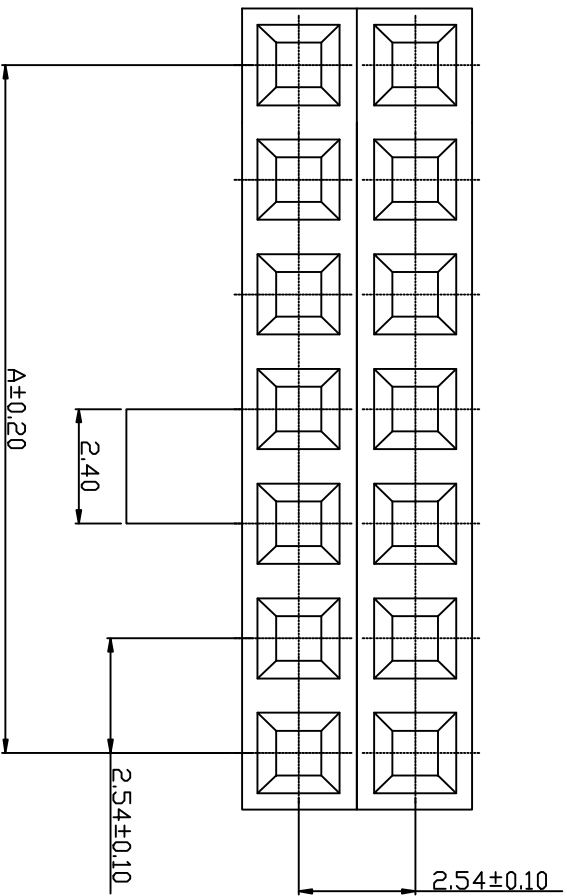
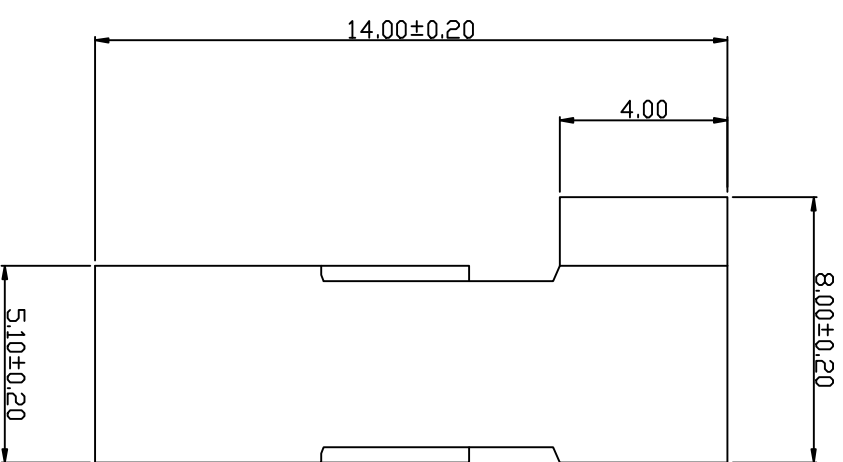
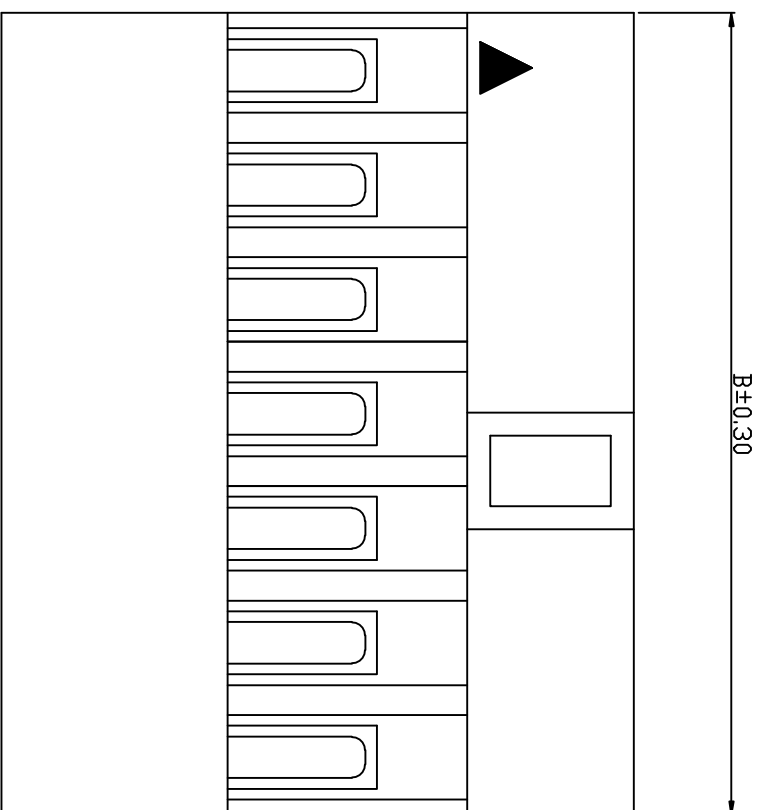

- SPECIFICATIONS**
- Voltage rating: 250V AC, DC
  - Current rating: 3A, AC, DC
  - Withstanding Voltage: 1500V AC/minute
  - Insulation resistance: 1000MΩ min
  - Temperature range: -40℃~+85℃
  - Contact resistance: 20MΩ max
- HOUSING**
- Part No: H2544LT-2\*NP
  - Poles: 04-80
  - Material: PBT UL94V-0

| Part No      | Dimensions (mm) |       |
|--------------|-----------------|-------|
|              | A               | B     |
| H2544LT-2*02 | 2.54            | 5.08  |
| H2544LT-2*03 | 5.08            | 7.62  |
| H2544LT-2*04 | 7.62            | 10.16 |
| H2544LT-2*05 | 10.16           | 12.70 |
| H2544LT-2*06 | 12.70           | 15.24 |
| H2544LT-2*07 | 15.24           | 17.78 |
| H2544LT-2*08 | 17.78           | 20.32 |
| H2544LT-2*09 | 20.32           | 22.86 |
| H2544LT-2*10 | 22.86           | 25.40 |
| H2544LT-2*11 | 25.40           | 27.94 |
| H2544LT-2*12 | 27.94           | 30.48 |
| H2544LT-2*13 | 30.48           | 33.02 |
| H2544LT-2*14 | 33.02           | 35.56 |
| H2544LT-2*15 | 35.56           | 38.10 |
| H2544LT-2*16 | 38.10           | 40.64 |
| H2544LT-2*17 | 40.64           | 43.18 |
| H2544LT-2*18 | 43.18           | 45.72 |
| H2544LT-2*19 | 45.72           | 48.26 |
| H2544LT-2*20 | 48.26           | 50.80 |

| Part No      | Dimensions (mm) |        |
|--------------|-----------------|--------|
|              | A               | B      |
| H2544LT-2*21 | 50.80           | 53.34  |
| H2544LT-2*22 | 53.34           | 55.88  |
| H2544LT-2*23 | 55.88           | 58.42  |
| H2544LT-2*24 | 58.42           | 60.96  |
| H2544LT-2*25 | 60.96           | 63.50  |
| H2544LT-2*26 | 63.50           | 66.04  |
| H2544LT-2*27 | 66.04           | 68.58  |
| H2544LT-2*28 | 68.58           | 71.12  |
| H2544LT-2*29 | 71.12           | 73.66  |
| H2544LT-2*30 | 73.66           | 76.20  |
| H2544LT-2*31 | 76.20           | 78.74  |
| H2544LT-2*32 | 78.74           | 81.28  |
| H2544LT-2*33 | 81.28           | 83.82  |
| H2544LT-2*34 | 83.82           | 86.36  |
| H2544LT-2*35 | 86.36           | 88.90  |
| H2544LT-2*36 | 88.90           | 91.44  |
| H2544LT-2*37 | 91.44           | 93.98  |
| H2544LT-2*38 | 93.98           | 96.52  |
| H2544LT-2*39 | 96.52           | 99.06  |
| H2544LT-2*40 | 99.06           | 101.60 |

**KLT** 深圳市康利通电子科技有限公司

TOLERANCE

0±0.30

.0±0.25

.00±0.20

.000±0.015

|            |              |        |
|------------|--------------|--------|
| TITLE      | 成品规格图        |        |
| CHECKED BY | DATE         | SCALE  |
| DRAWN BY   | UNIT:mm      | VER No |
| PART No    | H2544LT-2*NP | SIZE   |

1

4

B

C

D

E

F