

B

C

E

公差表

REV	ECN NO	LOCATIONS	DESCRIPTION	DATE	CHANGER
A			新版本	2016-05-25	李国常

4

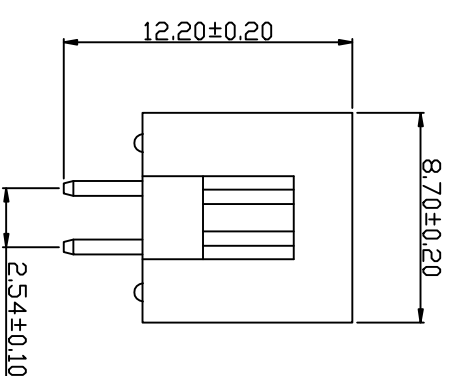
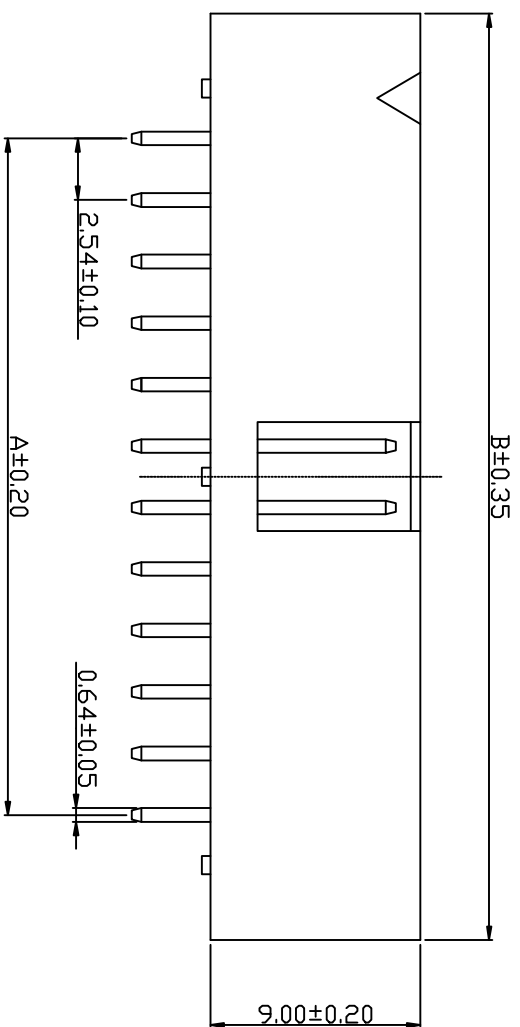
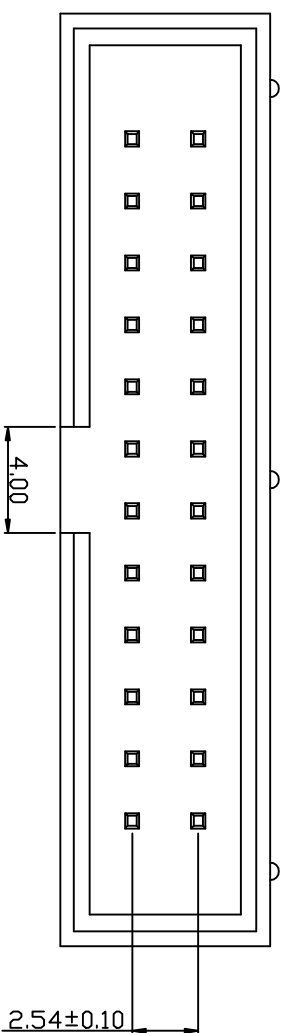

Part No	Dimensions (mm)	
	A	B
WJL2544V-2*03	5.08	15.24
WJL2544V-2*04	7.62	17.78
WJL2544V-2*05	10.16	20.32
WJL2544V-2*06	12.70	22.86
WJL2544V-2*07	15.24	25.40
WJL2544V-2*08	17.78	27.94
WJL2544V-2*10	20.32	33.02
WJL2544V-2*12	27.94	38.10
WJL2544V-2*13	30.48	40.64
WJL2544V-2*15	35.56	45.72
WJL2544V-2*17	40.64	50.80
WJL2544V-2*20	48.26	58.42
WJL2544V-2*22	53.34	63.50
WJL2544V-2*24	58.42	68.58
WJL2544V-2*25	60.96	71.12
WJL2544V-2*30	73.66	83.82
WJL2544V-2*32	78.74	88.90

- SPECIFICATIONS**
- Voltage rating: 250V AC, DC
  - Current rating: 3A, AC, DC
  - Withstanding Voltage: 1000V AC/minute
  - Insulation resistance: 1000MΩ min
  - Temperature range: -40°C~+105°C
  - Contact resistance: 20MΩ max
- WAFER
- Part No: WJL2544V-2\*NP
  - Poles: 06-64
  - Material: PBT UL94V-0
  - Pin Material: Brass /Gold-flash

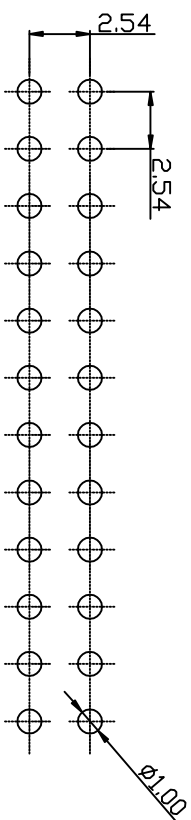

P.C.B LAYOUT

**KLT** 深圳市康利通电子科技有限公司

成品规格图

TOLERANCE

0±0.30

.0±0.25

.00±0.20

.000±0.015

1

TITLE	成品规格图		TOLERANCE	
CHECKED BY	DATE	SCALE	VER No	SIZE
	2016-05-25	1:1	A	A4

DRAWN BY	UNIT:mm		A	A4
----------	---------	--	---	----

李国常	PART No	WJL2544V-2*NP
-----	---------	---------------

B

C

D

E

F

4

B

C

E

公差表

REV	ECN NO	LOCATIONS	DESCRIPTION	DATE	CHANGER
A			新版本	2016-05-25	李国常

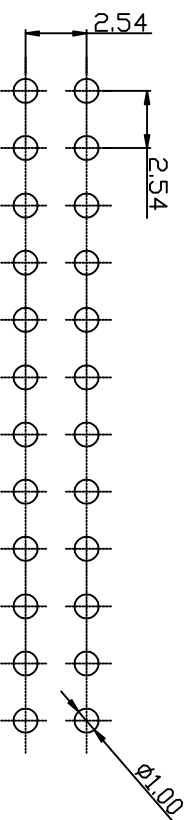
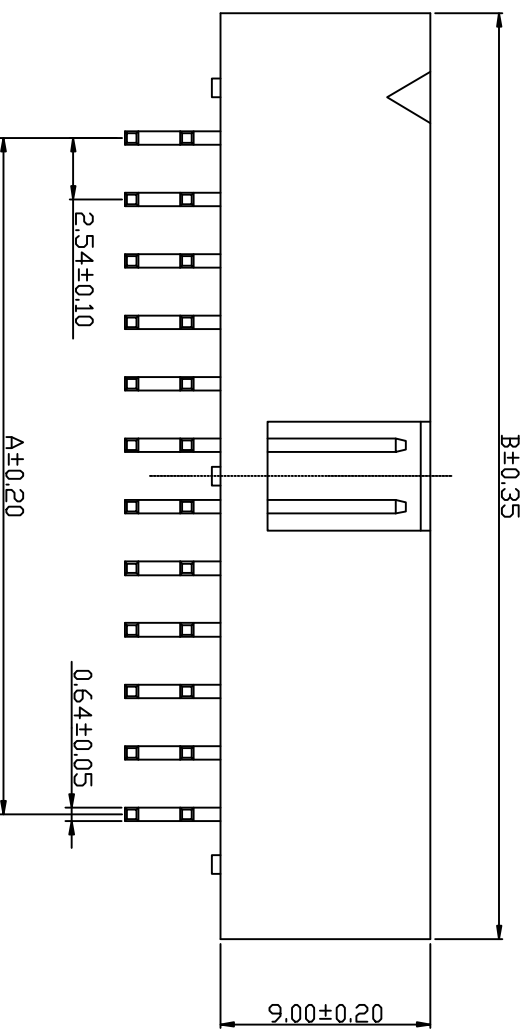
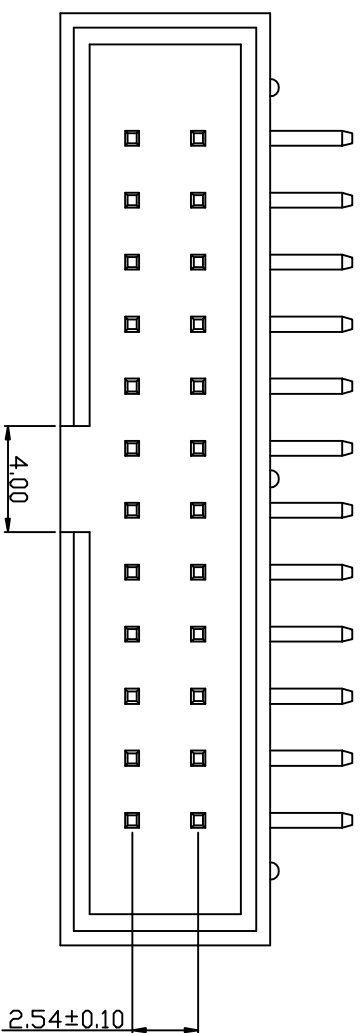

P.C.B LAYOUT

SPECIFICATIONS

- Voltage rating: 250V AC, DC
  - Current rating: 3A, AC, DC
  - Withstanding Voltage: 1000V AC/minute
  - Insulation resistance: 1000MΩ min
  - Temperature range: -40°C~+105°C
  - Contact resistance: 20MΩ max
- WAFER
- Part No: WJL2544R-2\*NP
  - Poles: 06-64
  - Material: PBT UL94V-0
  - Pin Material: Brass /Gold-flash

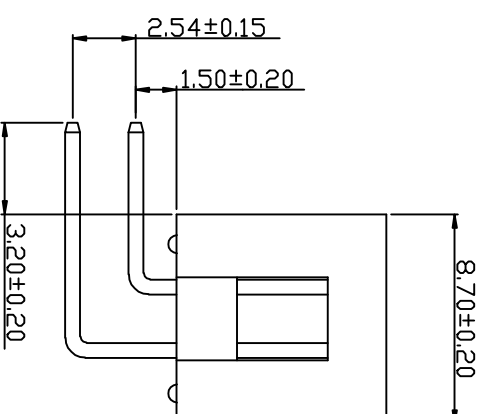

Part NO	Dimensions (mm)	
	A	B
WJL2544R-2*03	5.08	15.24
WJL2544R-2*04	7.62	17.78
WJL2544R-2*05	10.16	20.32
WJL2544R-2*06	12.70	22.86
WJL2544R-2*07	15.24	25.40
WJL2544R-2*08	17.78	27.94
WJL2544R-2*10	20.32	33.02
WJL2544R-2*12	27.94	38.10
WJL2544R-2*13	30.48	40.64
WJL2544R-2*15	35.56	45.72
WJL2544R-2*17	40.64	50.80
WJL2544R-2*20	48.26	58.42
WJL2544R-2*22	53.34	63.50
WJL2544R-2*24	58.42	68.58
WJL2544R-2*25	60.96	71.12
WJL2544R-2*30	73.66	83.82
WJL2544R-2*32	78.74	88.90

**KLT** 深圳市康利通电子科技有限公司

成品规格图

TOLERANCE

0±0.30

.0±0.25

.00±0.20

.000±0.015

TITLE	成品规格图		TOLERANCE	
CHECKED BY	DATE	SCALE	VER No	SIZE
	2016-05-25	1:1	A	A4
DRAWN BY	UNIT:mm			
李国常				
PART NO	WJL2544R-2*NP			

4

4

B

C

D

E

F

1