

B

C

E

公差表

REV	ECN NO	LOCATIONS	DESCRIPTION	DATE	CHANGER
A			新版本	2016-05-26	李国常

SPECIFICATIONS

- Voltage rating: 150V AC, DC
- Current rating: 3A, AC, DC
- Withstanding Voltage: 1000V AC/minute
- Insulation resistance: 500MΩ min
- Temperature range: -40℃~+85℃
- Contact resistance: 10MΩ max

HOUSING

- Part No: H2545-NP
- Poles: 02-20
- Material: Nylon 66 UL94V-2+15% CF

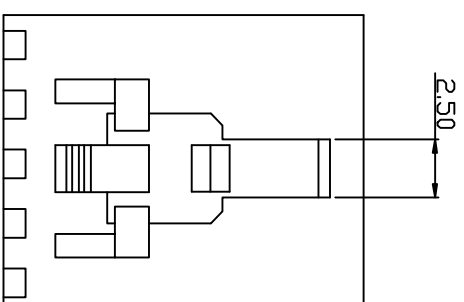
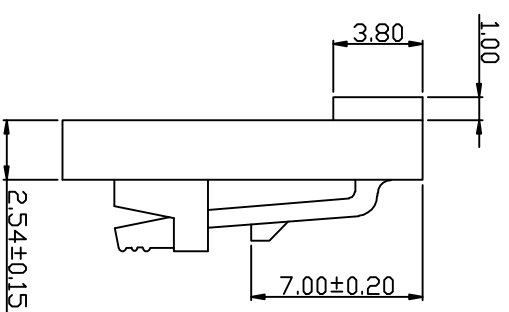
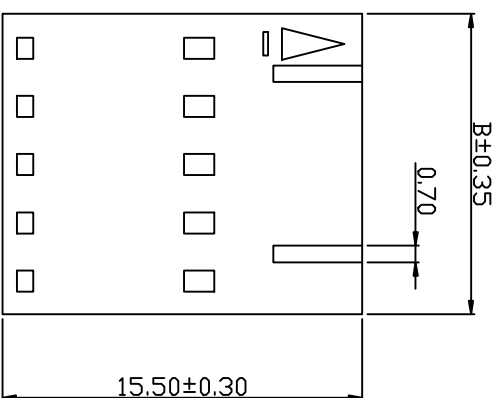

Part No	Dimensions (mm)	
	A	B
H2545-02	2.54	5.08
H2545-03	5.08	7.62
H2545-04	7.62	10.16
H2545-05	10.16	12.70
H2545-06	12.70	15.24
H2545-07	15.24	17.78
H2545-08	17.78	20.32
H2545-09	20.32	22.86
H2545-10	22.86	25.40
H2545-11	25.40	27.94
H2545-12	27.94	30.48
H2545-13	30.48	33.02
H2545-14	33.02	35.56
H2545-15	35.56	38.10
H2545-16	38.10	40.64
H2545-17	40.64	43.18
H2545-18	43.18	45.72
H2545-19	45.72	48.26
H2545-20	48.26	50.80

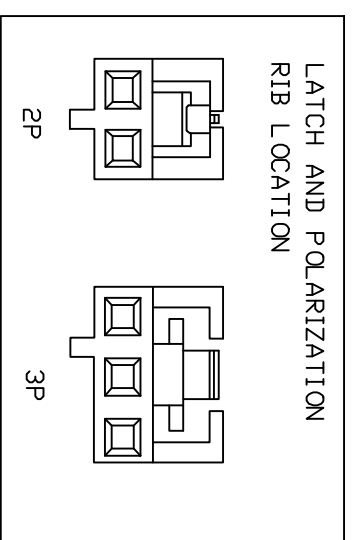
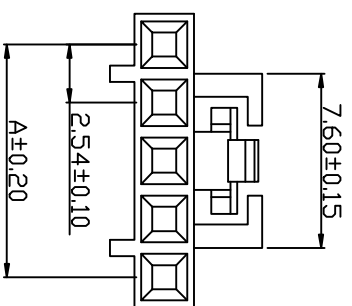

KLT 深圳市康利通电子科技有限公司

TOLERANCE

0±0.30

.0±0.25

.00±0.20

.000±0.015

VER No SIZE

A A4

成品规格图

TITLE

CHECKED BY

DATE

SCALE

2016-05-26

1:1

DRAWN BY

UNIT:mm



李国常

PART No

H2545-NP

4

4

B

C

D

E

F

1

B

C

E

公差表

REV	ECN NO	LOCATIONS	DESCRIPTION	DATE	CHANGER
A			新版本	2016-05-26	李国常

SPECIFICATIONS

- Voltage rating: 150V AC, DC
- Current rating: 3A, AC, DC
- Withstanding Voltage: 1000V AC/minute
- Insulation resistance: 500MΩ min
- Temperature range: -40℃~+85℃
- Contact resistance: 10MΩ max

HOUSING

- Part No: H2545NK-NP
- Poles: 02-20
- Material: Nylon 66 UL 94V-2+15% CF

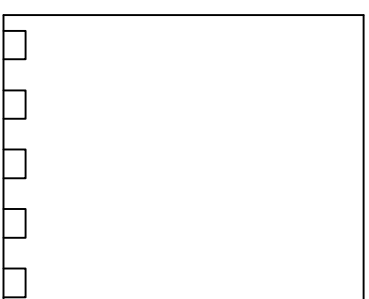
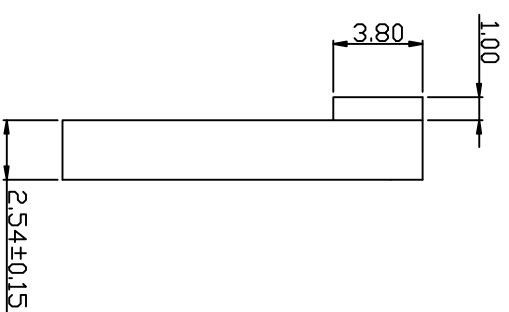
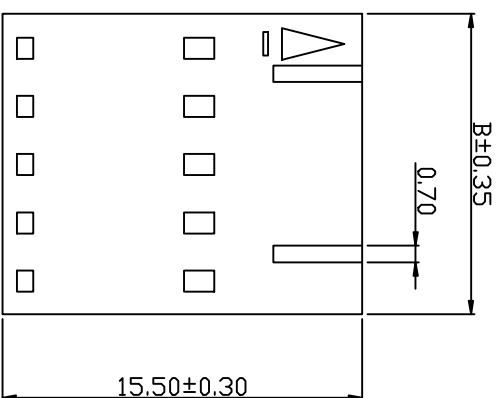

Part No	Dimensions (mm)	
	A	B
H2545NK-02	2.54	5.08
H2545NK-03	5.08	7.62
H2545NK-04	7.62	10.16
H2545NK-05	10.16	12.70
H2545NK-06	12.70	15.24
H2545NK-07	15.24	17.78
H2545NK-08	17.78	20.32
H2545NK-09	20.32	22.86
H2545NK-10	22.86	25.40
H2545NK-11	25.40	27.94
H2545NK-12	27.94	30.48
H2545NK-13	30.48	33.02
H2545NK-14	33.02	35.56
H2545NK-15	35.56	38.10
H2545NK-16	38.10	40.64
H2545NK-17	40.64	43.18
H2545NK-18	43.18	45.72
H2545NK-19	45.72	48.26
H2545NK-20	48.26	50.80

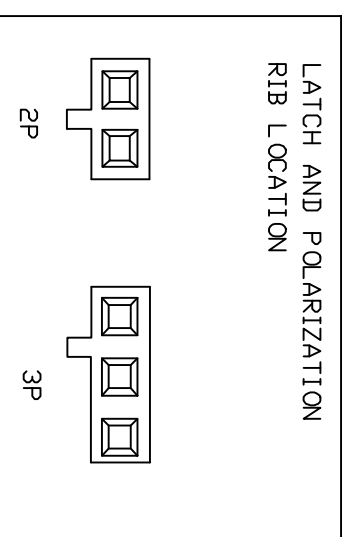
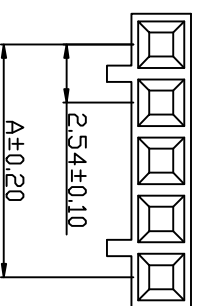

KLT 深圳市康利通电子科技有限公司

TOLERANCE

0±0.30

.0±0.25

.00±0.20

.000±0.015

TITLE	成品规格图			
CHECKED BY	DATE	SCALE	VER No	SIZE
	2016-05-26	1:1	A	A4

DRAWN BY	UNIT:mm			
李国常		PART No	H2545NK-NP	

4

4

B

C

D

E

F

1

B

C

E

公差表

REV	ECN NO	LOCATIONS	DESCRIPTION	DATE	CHANGER
A			新版本	2016-05-26	李国常

SPECIFICATIONS

- Voltage rating: 250V AC, DC
- Current rating: 3A, AC, DC
- Withstanding Voltage: 1500V AC/minute
- Insulation resistance: 1000MΩ min
- Temperature range: -40℃~+85℃
- Contact resistance: 20MΩ max

HOUSING

- Part No: H2545NKT-NP
- Poles: 02-24
- Material: Nylon 66 UL94V-2+15%; CF

4

4

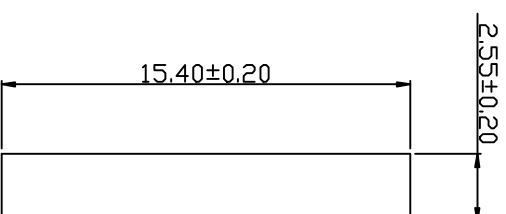
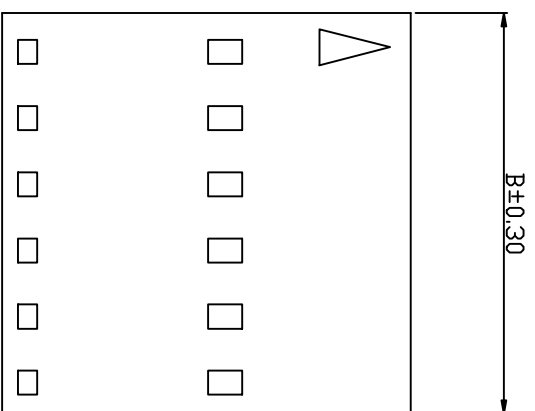

Part No	Dimensions (mm)	
	A	B
H2545NKT-02	2.54	5.08
H2545NKT-03	5.08	7.62
H2545NKT-04	7.62	10.16
H2545NKT-05	10.16	12.70
H2545NKT-06	12.70	15.24
H2545NKT-07	15.24	17.78
H2545NKT-08	17.78	20.32
H2545NKT-09	20.32	22.86
H2545NKT-10	22.86	25.40
H2545NKT-11	25.40	27.94
H2545NKT-12	27.94	30.48
H2545NKT-13	30.48	33.02

Part No	Dimensions (mm)	
	A	B
H2545NKT-14	33.02	35.56
H2545NKT-15	35.56	38.10
H2545NKT-16	38.10	40.64
H2545NKT-17	40.64	43.18
H2545NKT-18	43.18	45.72
H2545NKT-19	45.72	48.26
H2545NKT-20	48.26	50.80
H2545NKT-21	50.80	53.34
H2545NKT-22	53.34	55.88
H2545NKT-23	55.88	58.42
H2545NKT-24	58.42	60.96

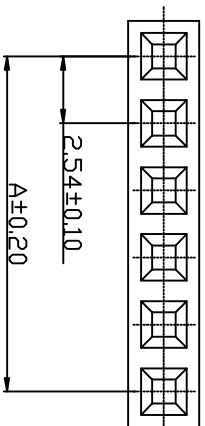

KLT 深圳市康利通电子科技有限公司

成品规格图

TOLERANCE

0±0.30

.0±0.25

.00±0.20

.000±0.015

1

TITLE	成品规格图	
CHECKED BY	DATE	SCALE
DRAWN BY	UNIT:mm	VER No
PART No	PART No	SIZE

李国常

2016-05-26

1:1

A

A4

H2545NKT-NP

B

C

D

E

F

B

C

E

公差表

REV	ECN NO	LOCATIONS	DESCRIPTION	DATE	CHANGER
A			新版本	2016-05-26	李国常

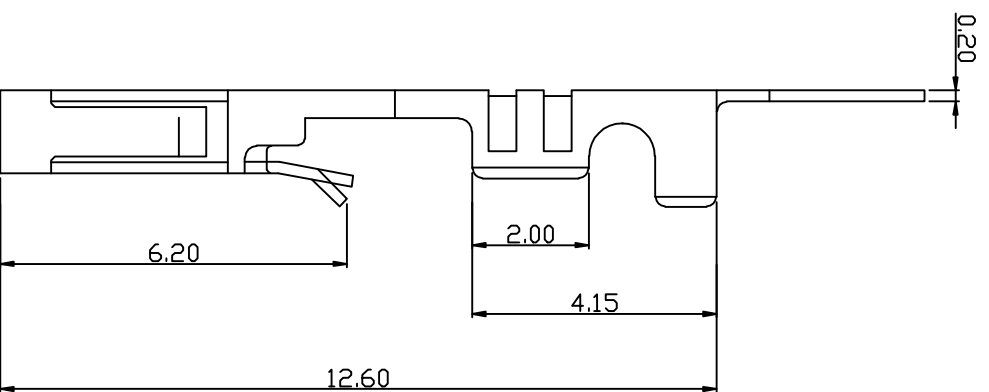
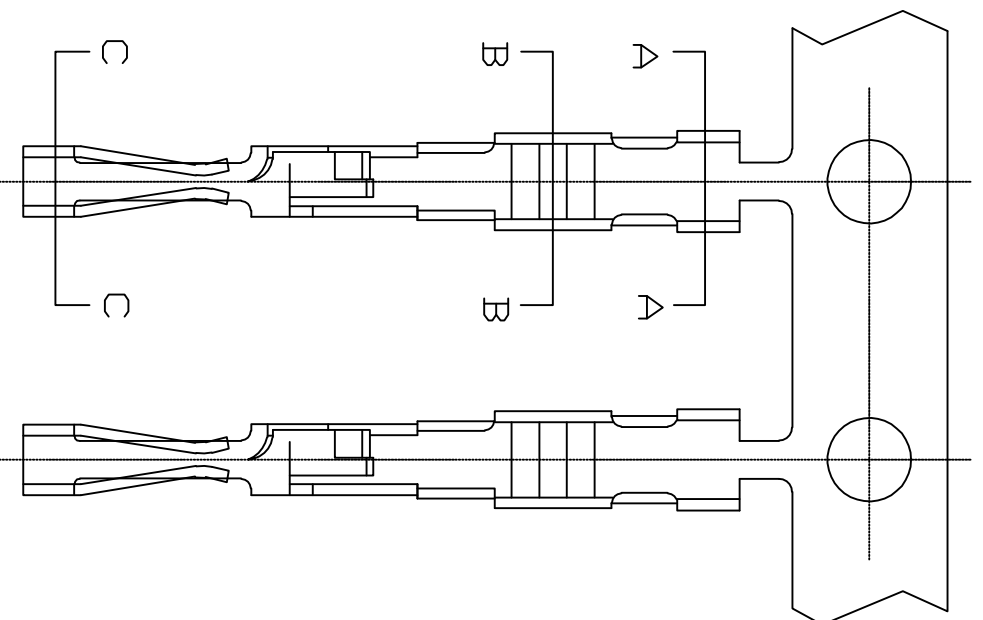

- SPECIFICATIONS**
- Voltage rating: 250V AC, DC
 - Current rating: 3A, AC, DC
 - Withstanding Voltage: 1000V AC/minute
 - Insulation resistance: 1000MΩ min
 - Temperature range: -40℃~+85℃
 - Contact resistance: 10MΩ max
- TERMINAL**
- Part No: T2545PT
 - Applicable wire: AWG#22-#26
 - Material: Phosphor Bronze
 - Finish: Tin plated

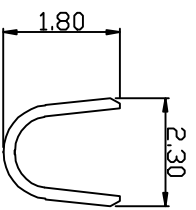

SEC: A-A

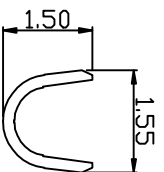

SEC: B-B

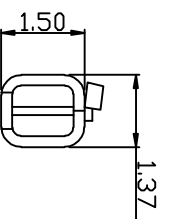

SEC: C-C

KLT 深圳市康利通电子科技有限公司

成品规格图

TOLERANCE

0±0.30

.0±0.25

.00±0.20

.000±0.015

1

TITLE	DATE	SCALE	VER No	SIZE
CHECKED BY	2016-05-26	1:1		

DRAWN BY	UNIT:mm		A	A4
----------	---------	--	---	----

李国常	PART No	T2545PT
-----	---------	---------

B

C

D

E

F

4

4