

B

C

E

公差表

REV	ECN NO	LOCATIONS	DESCRIPTION	DATE	CHANGER
A			新版本	2016-05-16	李国常

**SPECIFICATIONS**

- Voltage rating: 250V AC, DC
- Current rating: 3A, AC, DC
- Withstanding Voltage: 800V AC/minute
- Insulation resistance: 100MΩ min
- Temperature range: -40℃~+85℃
- Contact resistance: 10MΩ max

**HOUSING**

- Part No: H2507-NP
- Poles: 02-16
- Material: Nylon 66 UL94V-0

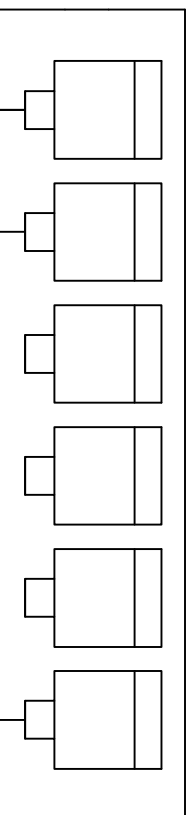
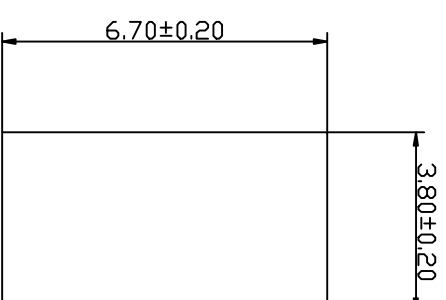
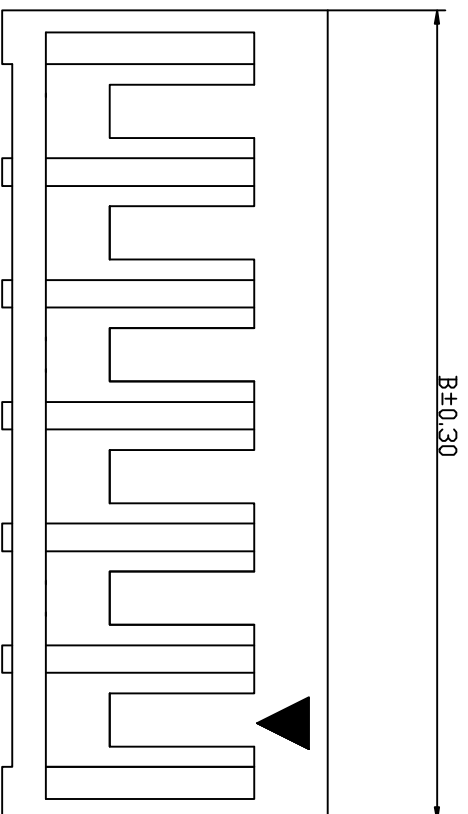

Part No	Dimensions (mm)	
	A	B
H2507-02	2.50	6.50
H2507-03	5.00	9.00
H2507-04	7.50	11.50
H2507-05	10.00	14.00
H2507-06	12.50	16.50
H2507-07	15.00	19.00
H2507-08	17.50	21.50
H2507-09	20.00	24.00
H2507-10	22.50	26.50
H2507-11	25.00	29.00
H2507-12	27.50	31.50
H2507-13	30.00	34.00
H2507-14	32.50	36.50
H2507-15	35.00	39.00
H2507-16	37.50	41.50

**KLT** 深圳市康利通电子科技有限公司

成品规格图

TOLERANCE

0±0.30

.0±0.25

.00±0.20

.000±0.015

TITLE	成品规格图		TOLERANCE	
CHECKED BY	DATE	SCALE	VER No	SIZE
2016-05-16	1:1		A	A4
DRAWN BY	UNIT:mm			
李国常	PART No	H2507-NP		

4

4

B

C

D

E

F

1

B

C

E

公差表

REV	ECN NO	LOCATIONS	DESCRIPTION	DATE	CHANGER
A			新版本	2016-05-16	李国常

**SPECIFICATIONS**

- Voltage rating: 250V AC, DC
- Current rating: 3A, AC, DC
- Withstanding Voltage: 800V AC/minute
- Insulation resistance: 100MΩ min
- Temperature range: -40℃~+85℃
- Contact resistance: 10MΩ max

**HOUSING**

- Part No: H2507R-NP
- Poles: 02-16
- Material: Nylon 66 UL94V-0

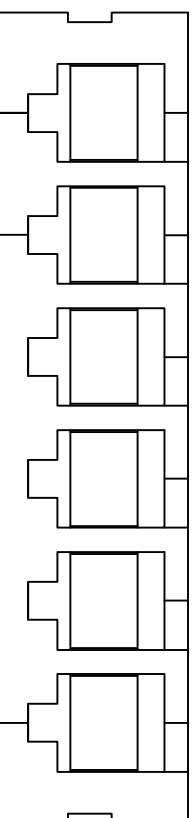
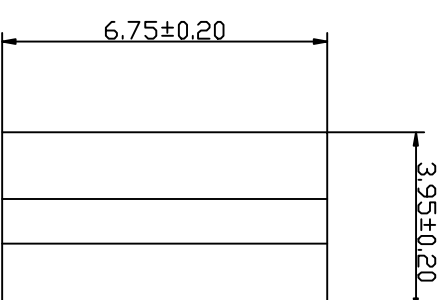
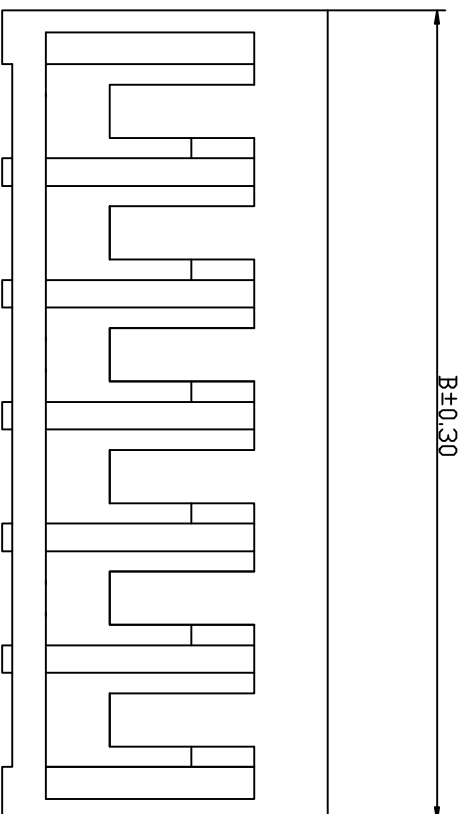

Part No	Dimensions (mm)	
	A	B
H2507R-02	2.50	5.90
H2507R-03	5.00	8.40
H2507R-04	7.50	10.90
H2507R-05	10.00	13.40
H2507R-06	12.50	15.90
H2507R-07	15.00	18.40
H2507R-08	17.50	20.90
H2507R-09	20.00	23.40
H2507R-10	22.50	25.90
H2507R-11	25.00	28.40
H2507R-12	27.50	30.90
H2507R-13	30.00	33.40
H2507R-14	32.50	35.90
H2507R-15	35.00	38.40
H2507R-16	37.50	40.90

**KLT** 深圳市康利通电子科技有限公司

成品规格图

TOLERANCE

0±0.30

.0±0.25

.00±0.20

.000±0.015

TITLE	成品规格图		TOLERANCE	
CHECKED BY	DATE	SCALE	VER No	SIZE
	2016-05-16	1:1	A	A4
DRAWN BY	UNIT:mm			
李国常	PART No	H2507R-NP		

4

4

B

C

D

E

F

1

B

C

E

公差表

REV	ECN NO	LOCATIONS	DESCRIPTION	DATE	CHANGER
A			新版本	2016-05-16	李国常

4

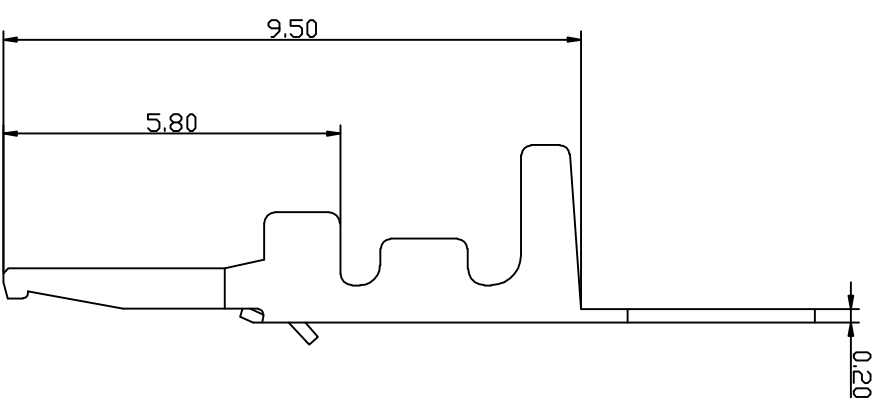
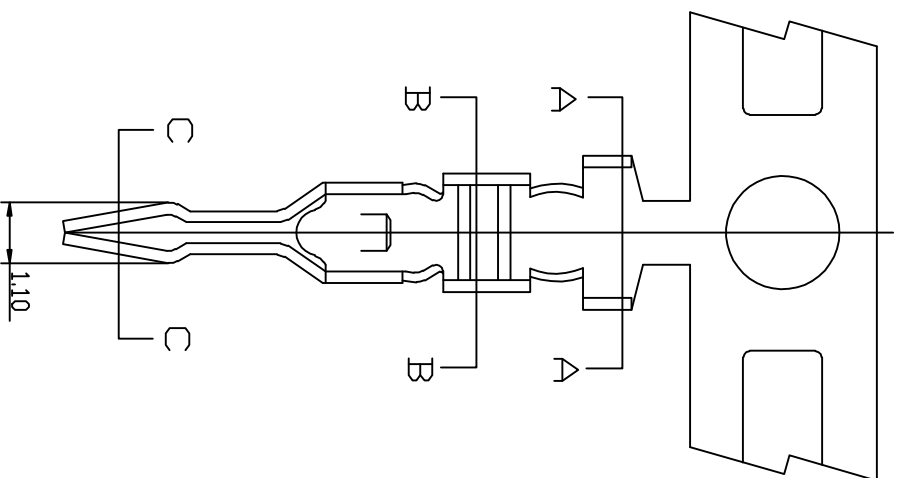

- SPECIFICATIONS**
- Voltage rating: 250V AC, DC
  - Current rating: 3A, AC, DC
  - Withstanding Voltage: 1000V AC/minute
  - Insulation resistance: 1000MΩ min
  - Temperature range: -40℃~+85℃
  - Contact resistance: 10MΩ max
- TERMINAL**
- Part No: T2507BT
  - Applicable wire: AWG#22-#28
  - Material: Brass
  - Finish: Tin plated

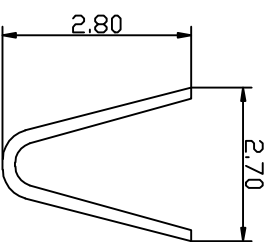

SEC:A-A

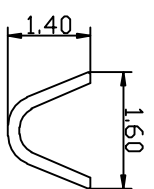

SEC:B-B

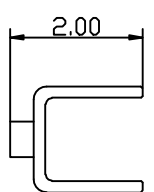

SEC:C-C

**KLT** 深圳市康利通电子科技有限公司

成品规格图

TOLERANCE

0±0.30

.0±0.25

.00±0.20

.000±0.015

1

TITLE	DATE	SCALE	VER No	SIZE
CHECKED BY	2016-05-16	1:1		
DRAWN BY	UNIT:mm		A	A4
李国常	PART No	T2507BT		

B

C

D

E

F

4

B

C

E

公差表

REV	ECN NO	LOCATIONS	DESCRIPTION	DATE	CHANGER
A			新版本	2016-05-16	李国常

**SPECIFICATIONS**

- Voltage rating: 250V AC, DC
- Current rating: 3A, AC, DC
- Withstanding Voltage: 1000V AC/minute
- Insulation resistance: 1000MΩ min
- Temperature range: -40℃~+85℃
- Contact resistance: 10MΩ max

**TERMINAL**

- Part No: T2507RBT
- Applicable wire: AWG#22-#28
- Material: Brass
- Finish: Tin plated

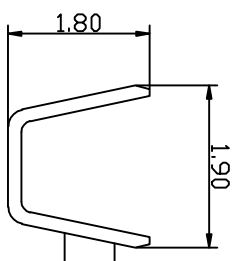
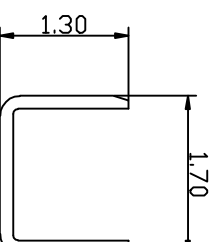
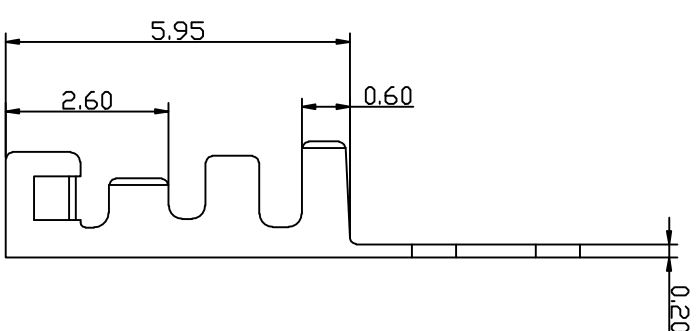
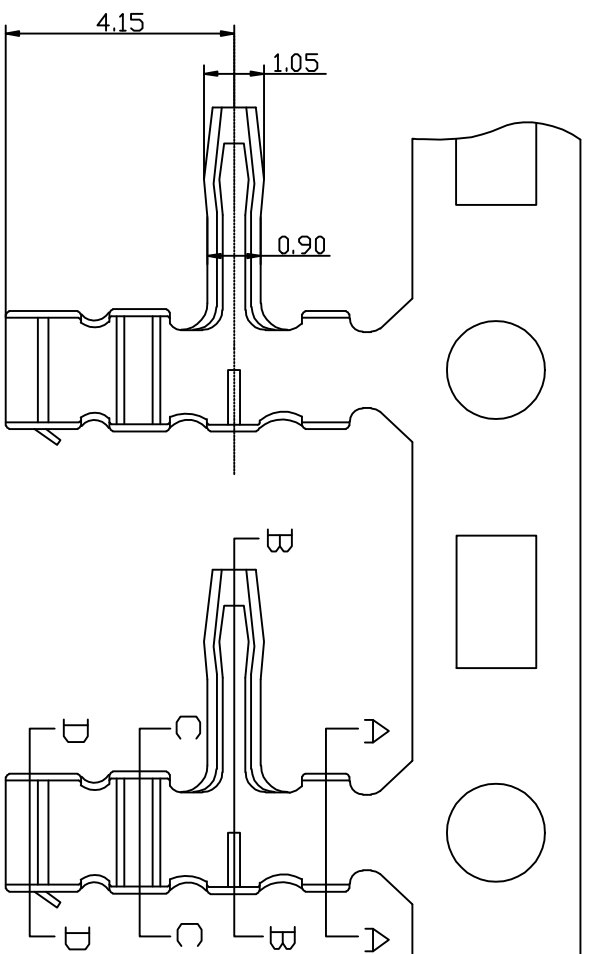

SEC: C-C

SEC: D-D

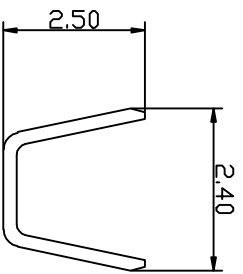

SEC: A-A

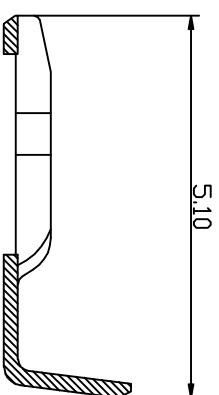

SEC: B-B

**KLIT** 深圳市康利通电子科技有限公司

TITLE

成品规格图

TO CERANCE

0±0.30

.0±0.25

.00±0.20

.000±0.015

1

CHECKED BY	DATE	SCALE	VER No	SIZE
	2016-05-16	1:1		

DRAWN BY	UNIT:mm	SCALE	VER No	SIZE
李国常		1:1	A	A4

PART No	DESCRIPTION
T2507RBT	

4

4

B

C

D

E

F