

B

C

E

公差表

REV	ECN NO	LOCATIONS	DESCRIPTION	DATE	CHANGER
A			新版本	2016-05-17	李国常

■ SPECIFICATIONS

- Voltage rating: 250V AC, DC
- Current rating: 3A, AC, DC
- Withstanding Voltage: 1000V AC/minute
- Insulation resistance: 1000MΩ min
- Temperature range: -40℃~+85℃
- Contact resistance: 20MΩ max

■ HOUSING

- Part No: H2516-NP
- Poles: 02-25
- Material: Nylon 66 UL94V-0

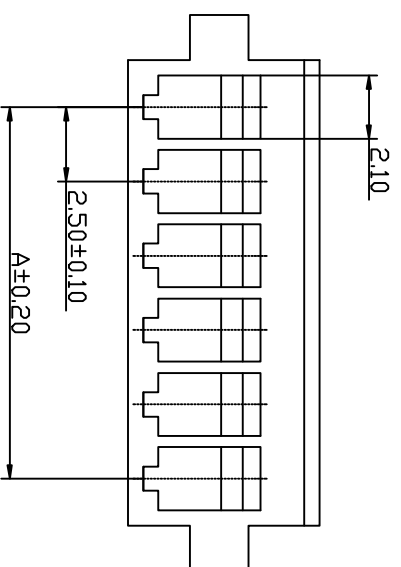
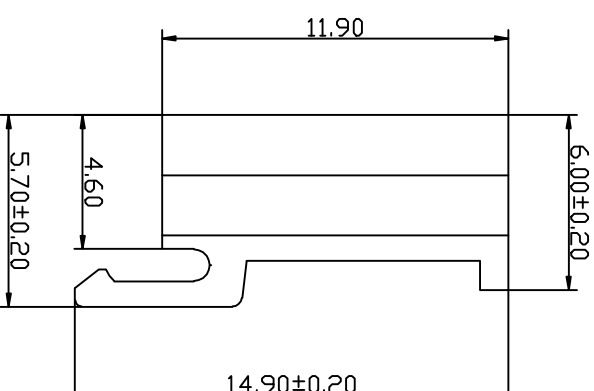
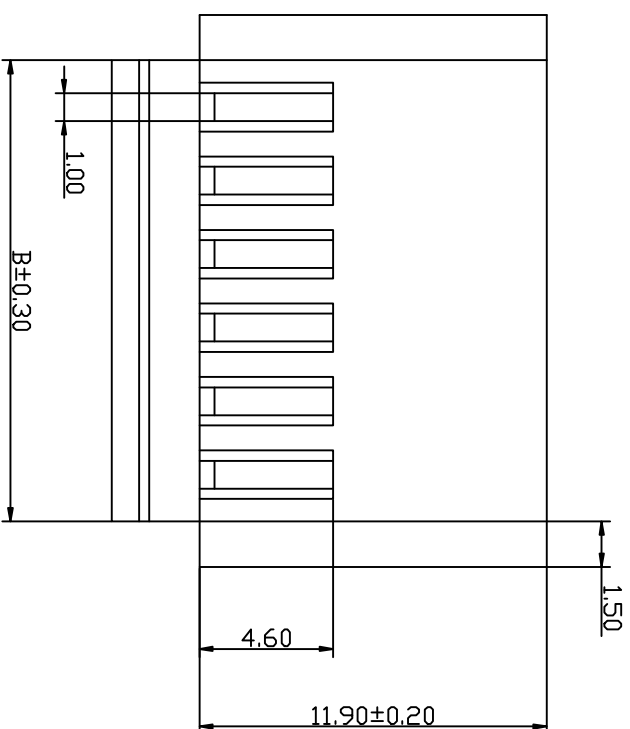

Part No	Dimensions (mm)	
	A	B
H2516-02	2.50	5.70
H2516-03	5.00	8.20
H2516-04	7.50	10.70
H2516-05	10.00	13.20
H2516-06	12.50	15.70
H2516-07	15.00	18.20
H2516-08	17.50	20.70
H2516-09	20.00	23.20
H2516-10	22.50	25.70
H2516-11	25.00	28.20
H2516-12	27.50	30.70
H2516-13	30.00	33.20
H2516-14	32.50	35.70
H2516-15	35.00	38.20
H2516-16	37.50	40.70

Part No	Dimensions (mm)	
	A	B
H2516-17	40.00	43.20
H2516-18	42.50	45.70
H2516-19	45.00	48.20
H2516-20	47.50	50.70
H2516-21	50.00	53.20
H2516-22	52.50	55.70
H2516-23	55.00	58.20
H2516-24	57.50	60.70
H2516-25	60.00	63.20

KLT 深圳市康利通电子科技有限公司

成品规格图

TO CERANCE

0±0.30

.0±0.25

.00±0.20

.000±0.015

TITLE	成品规格图		TO CERANCE	
CHECKED BY	DATE	SCALE	VER No	SIZE
	2016-05-17	1:1	A	A4
DRAWN BY	UNIT:mm			
李国常	PART No	H2516-NP		

4

4

B

C

D

E

F

1

B

C

E

公差表

REV	ECN NO	LOCATIONS	DESCRIPTION	DATE	CHANGER
A			新版本	2016-05-17	李国常

4

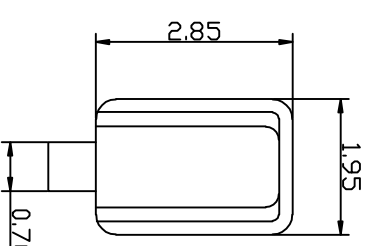
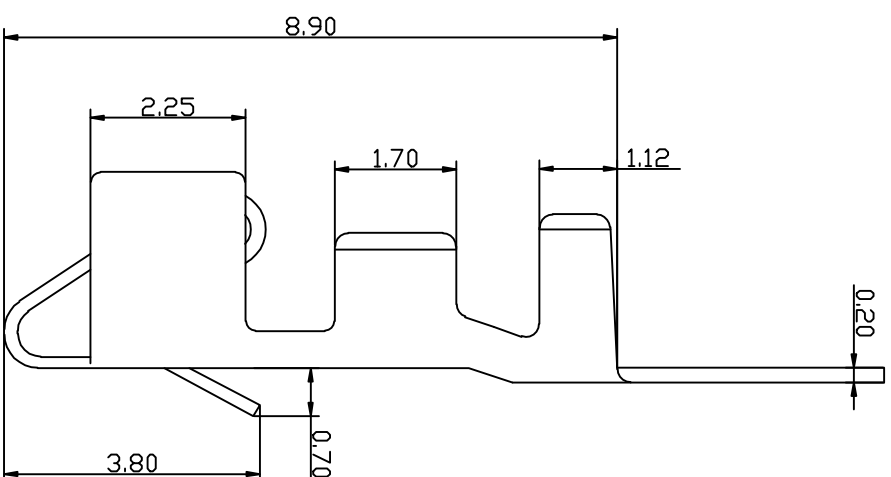
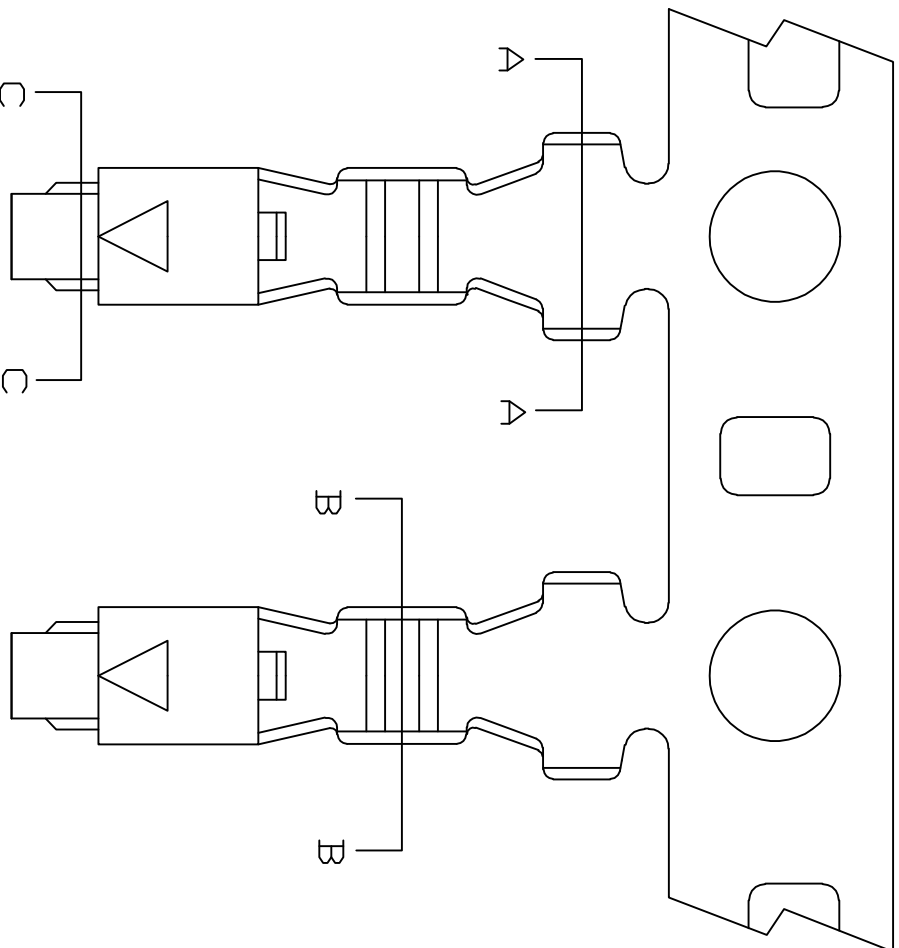

SEC: C-C

■ SPECIFICATIONS

- Voltage rating: 250V AC, DC
- Current rating: 3A, AC, DC
- Withstanding Voltage: 1000V AC/minute
- Insulation resistance: 1000MΩ min
- Temperature range: -40℃~+85℃
- Contact resistance: 10MΩ max

■ TERMINAL

- Part No: T2516BT
- Applicable wire: AWG#22-#28
- Material: Brass
- Finish: Tin plated

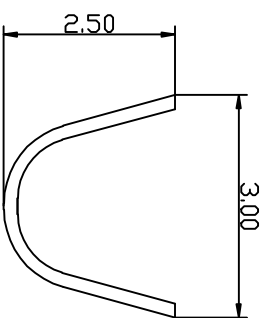

SEC: A-A

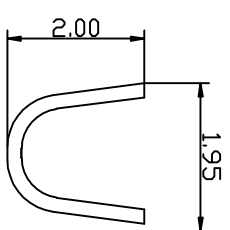

SEC: B-B

KLT 深圳市康利通电子科技有限公司

成品规格图

TOLERANCE

0±0.30

.0±0.25

.00±0.20

.000±0.015

1

TITLE	成品规格图		TOLERANCE	
CHECKED BY	DATE	SCALE	VER No	SIZE
DRAWN BY	UNIT:mm		A	A4
PART No	T2516BT			

李国常

UNIT:mm



A

A4

B

C

D

E

F

4

B

C

E

公差表

REV	ECN NO	LOCATIONS	DESCRIPTION	DATE	CHANGER
A			新版本	2016-05-17	李国常

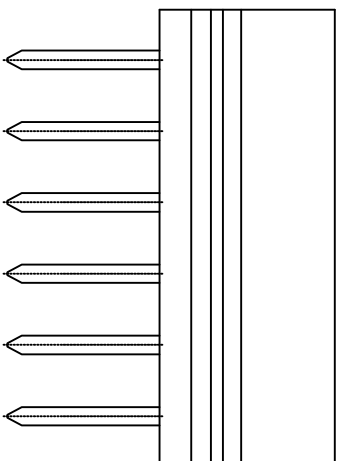

4

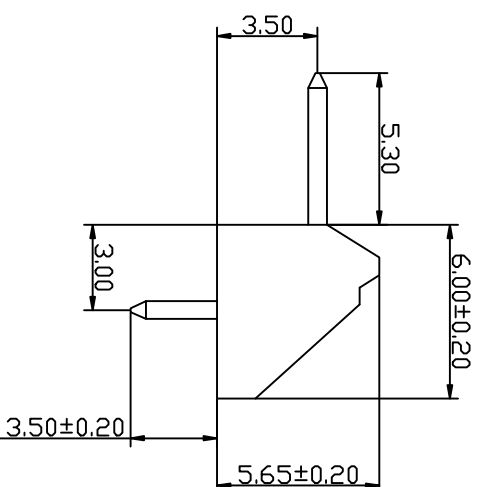
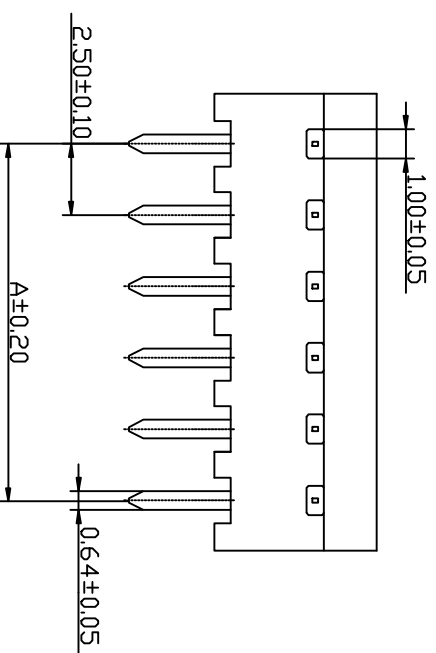

Part No	Dimensions (mm)	
	A	
W2516R-02	2.50	
W2516R-03	5.00	
W2516R-04	7.50	
W2516R-05	10.00	
W2516R-06	12.50	
W2516R-07	15.00	
W2516R-08	17.50	
W2516R-09	20.00	
W2516R-10	22.50	
W2516R-11	25.00	
W2516R-12	27.50	
W2516R-13	30.00	
W2516R-14	32.50	
W2516R-15	35.00	
W2516R-16	37.50	

Part No	Dimensions (mm)	
	A	
W2516R-17	40.00	
W2516R-18	42.50	
W2516R-19	45.00	
W2516R-20	47.50	
W2516R-21	50.00	
W2516R-22	52.50	
W2516R-23	55.00	
W2516R-24	57.50	
W2516R-25	60.00	

- SPECIFICATIONS**
- Voltage rating: 250V AC, DC
 - Current rating: 3A, AC, DC
 - Withstanding Voltage: 1500V AC/minute
 - Insulation resistance: 500MΩ min
 - Temperature range: -40℃~+85℃
 - Contact resistance: 15MΩ max
- WAFER
- Part No: W2516R-NP
 - Poles: 02-25
 - Material: Nylon 66 UL94V-0
 - Pin Material: Brass /Tin-plated

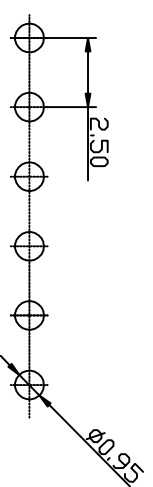

P.C.B LAYOUT

KLT 深圳市康利通电子科技有限公司

成品规格图

TOLERANCE

0±0.30

.0±0.25

.00±0.20

.000±0.015

VER No SIZE

A A4

TITLE	成品规格图		
CHECKED BY	DATE	SCALE	VER No SIZE
DRAWN BY	UNIT:mm		
PART No	W2516R-NP		

李国常

2016-05-17

1:1

A A4

W2516R-NP

B

C

D

E

F

1

4

B

C

E

公差表

REV	ECN NO	LOCATIONS	DESCRIPTION	DATE	CHANGER
A			新版本	2016-05-17	李国常

4

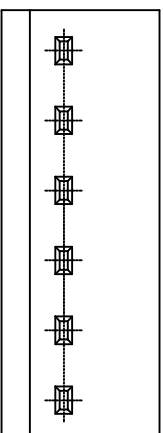

4

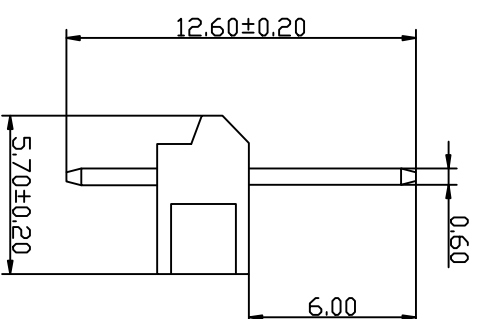
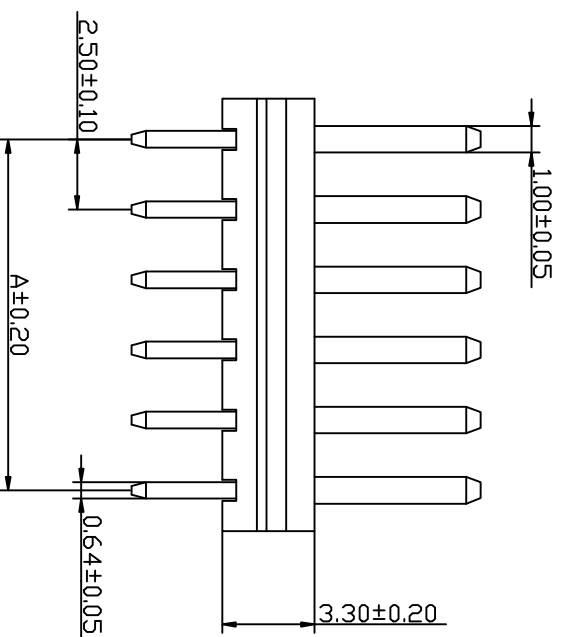

Part No	Dimensions (mm)	
	A	
W2516R-02	2.50	
W2516R-03	5.00	
W2516R-04	7.50	
W2516R-05	10.00	
W2516R-06	12.50	
W2516R-07	15.00	
W2516R-08	17.50	
W2516R-09	20.00	
W2516R-10	22.50	
W2516R-11	25.00	
W2516R-12	27.50	
W2516R-13	30.00	
W2516R-14	32.50	
W2516R-15	35.00	
W2516R-16	37.50	

Part No	Dimensions (mm)	
	A	
W2516R-17	40.00	
W2516R-18	42.50	
W2516R-19	45.00	
W2516R-20	47.50	
W2516R-21	50.00	
W2516R-22	52.50	
W2516R-23	55.00	
W2516R-24	57.50	
W2516R-25	60.00	

- SPECIFICATIONS**
- Voltage rating: 250V AC, DC
 - Current rating: 3A, AC, DC
 - Withstanding Voltage: 1500V AC/minute
 - Insulation resistance: 500MΩ min
 - Temperature range: -40℃~+85℃
 - Contact resistance: 15MΩ max
- WAFER
- Part No: W2516V-NP
 - Poles: 02-25
 - Material: Nylon 66 UL94V-0
 - Pin Material: Brass /Tin-plated

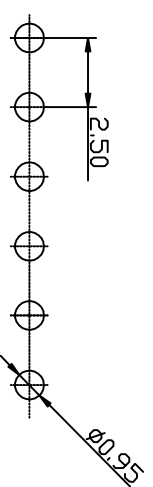

P.C.B LAYOUT

KLT 深圳市康利通电子科技有限公司

Tolerance

0±0.30

.0±0.25

.00±0.20

.000±0.015

VER No SIZE

A A4

TITLE	成品规格图		Tolerance	
CHECKED BY	DATE	SCALE	VER No	SIZE
DRAWN BY	UNIT:mm		A	A4
PART No	W2516V-NP			

李国常

2016-05-17

1:1

W2516V-NP

B

C

D

E

F

1