

B

C

E

公差表

REV	ECN NO	LOCATIONS	DESCRIPTION	DATE	CHANGER
A			新版本	2016-05-03	李国常

SPECIFICATIONS

- Voltage rating: 250V AC, DC
- Current rating: 3A, AC, DC
- Withstanding Voltage: 800V AC/minute
- Insulation resistance: 1000MΩ min
- Temperature range: -40℃~+85℃
- Contact resistance: 10MΩ max

HOUSING

- Part No: H2005-2*NP
- Poles: 04-40
- Material: Nylon 66 UL94V-0

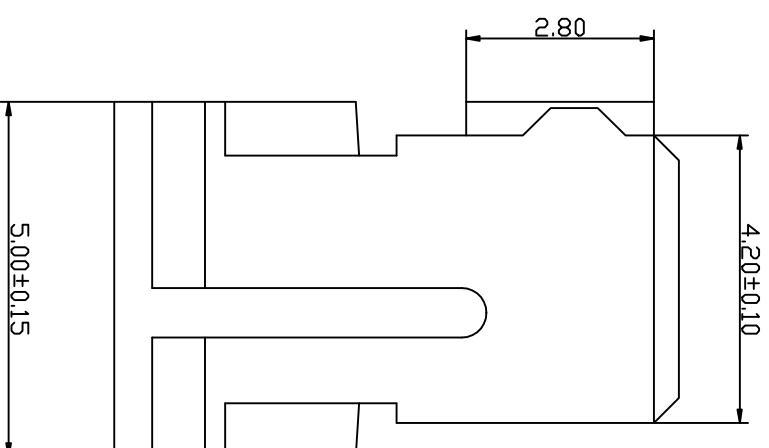
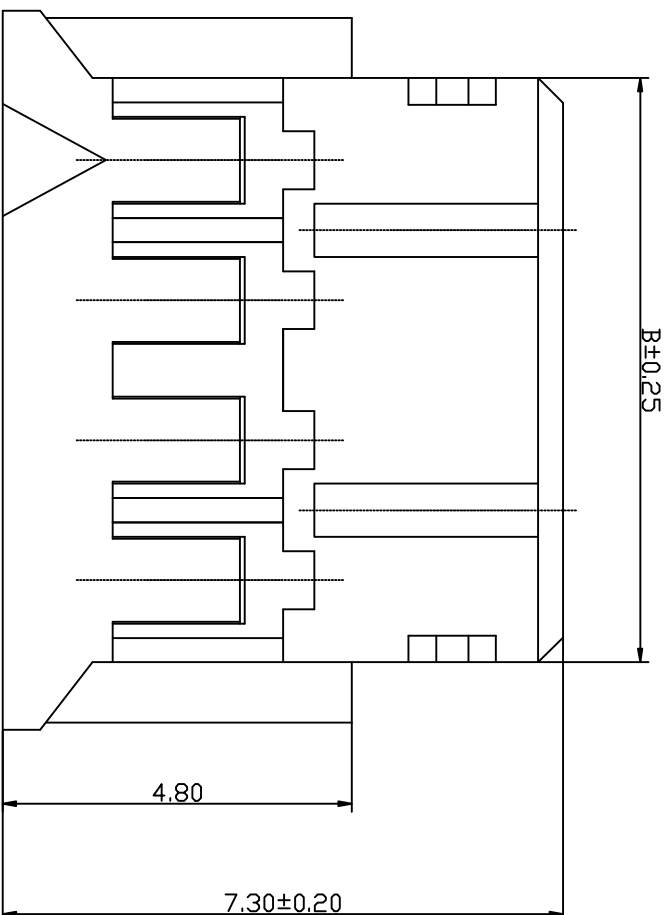

Part No	Dimensions (mm)	
	A	B
H2005-2*02	2.00	5.90
H2005-2*03	4.00	7.90
H2005-2*04	6.00	9.90
H2005-2*05	8.00	11.90
H2005-2*06	10.00	13.90
H2005-2*07	12.00	15.90
H2005-2*08	14.00	17.90
H2005-2*09	16.00	19.90
H2005-2*10	18.00	21.90
H2005-2*11	20.00	23.90
H2005-2*12	22.00	25.90
H2005-2*13	24.00	27.90
H2005-2*14	26.00	29.90
H2005-2*15	28.00	31.90
H2005-2*16	30.00	33.90
H2005-2*17	32.00	35.90
H2005-2*18	34.00	37.90
H2005-2*19	36.00	39.90
H2005-2*20	38.00	41.90

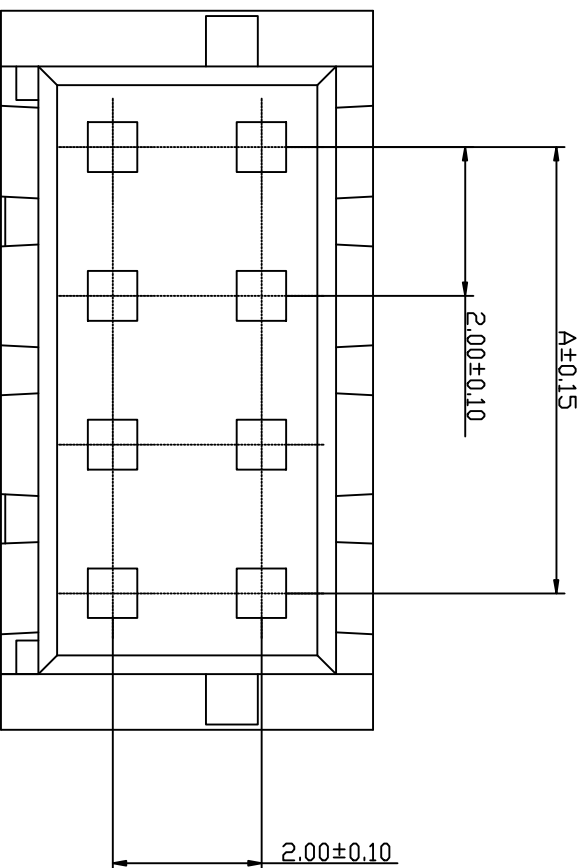

KLT 深圳市康利通电子科技有限公司

成品规格图

TOLERANCE

0±0.30

.0±0.25

.00±0.20

.000±0.015

TITLE	成品规格图		TOLERANCE	
CHECKED BY	DATE	SCALE	VER No	SIZE
	2016-05-03	1:1	A	A4
DRAWN BY	UNIT:mm			
李国常	PART No	H2005-2*NP		

4

4

B

C

D

E

F

1

B

C

E

公差表

REV	ECN NO	LOCATIONS	DESCRIPTION	DATE	CHANGER
A			新版本	2016-05-03	李国常

4

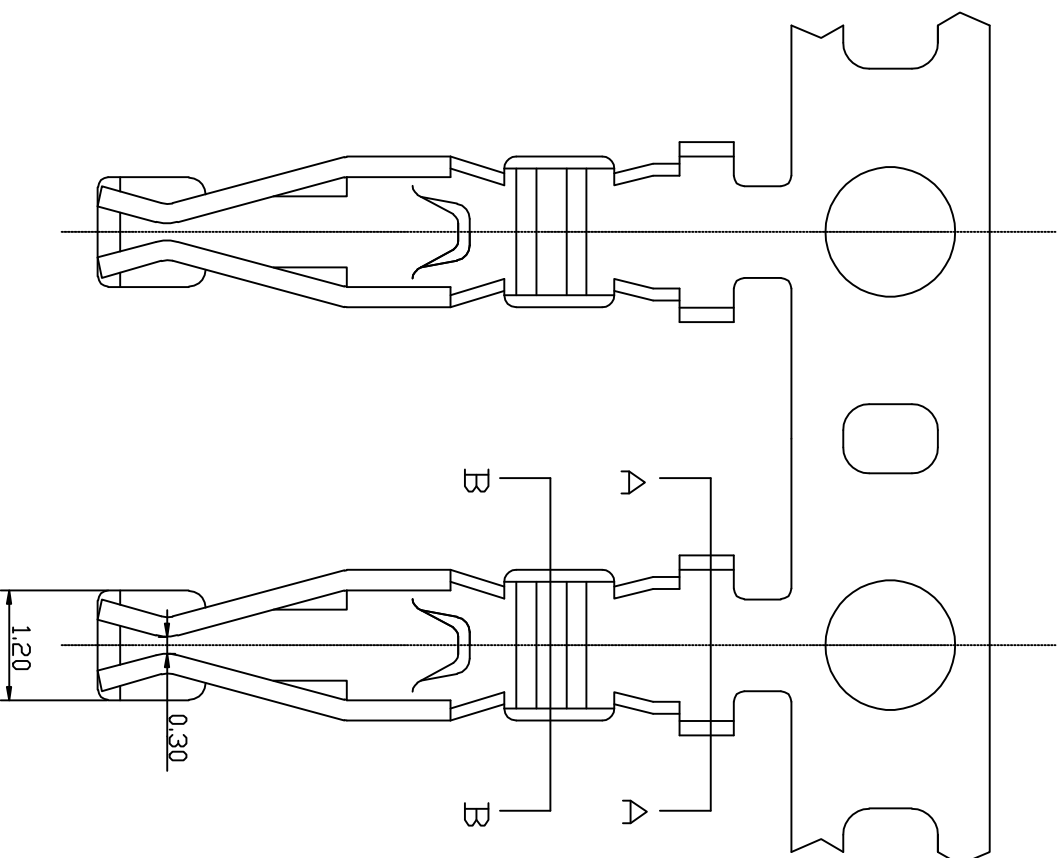

SEC: A-A

SEC: B-B

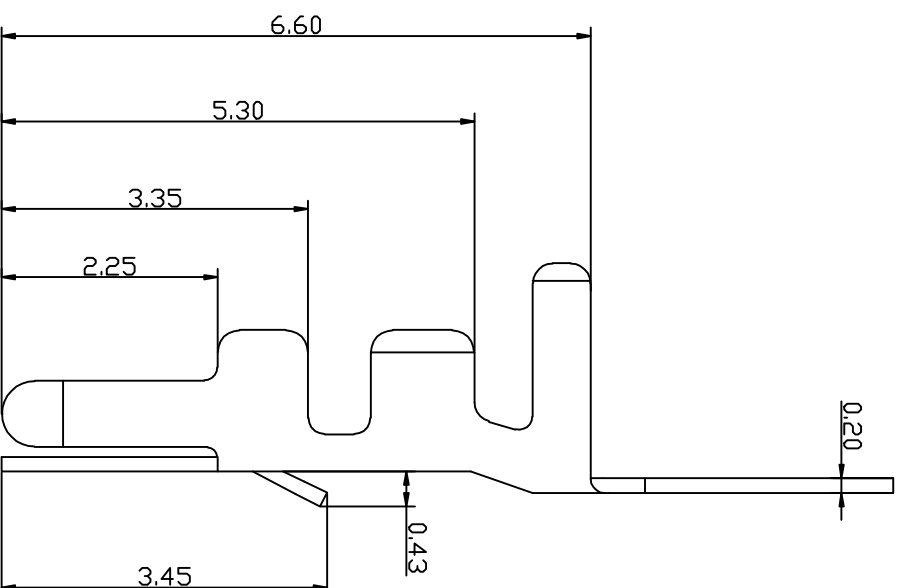

- SPECIFICATIONS**
- Voltage rating: 250V AC, DC
 - Current rating: 3A, AC, DC
 - Withstanding Voltage: 800V AC/minute
 - Insulation resistance: 1000MΩ min
 - Temperature range: -40℃~+85℃
 - Contact resistance: 10MΩ max
- TERMINAL**
- Part No: T2005PT
 - Applicable wire: AWG#22-#28
 - Material: Phosphor Bronze
 - Finish: Tin plated

4

KLT 深圳市康利通电子科技有限公司

成品规格图

TOCERANCE

0±0.30

.0±0.25

.00±0.20

.000±0.015

1

TITLE	DATE	SCALE	VER No	SIZE
CHECKED BY	2016-05-03	1:1		
DRAWN BY	UNIT:mm		A	A4
李国常	PART No	T2005PT		

B

C

D

E

F

B

C

E

公差表

REV	ECN NO	LOCATIONS	DESCRIPTION	DATE	CHANGER
A			新版本	2016-05-03	李国常

4

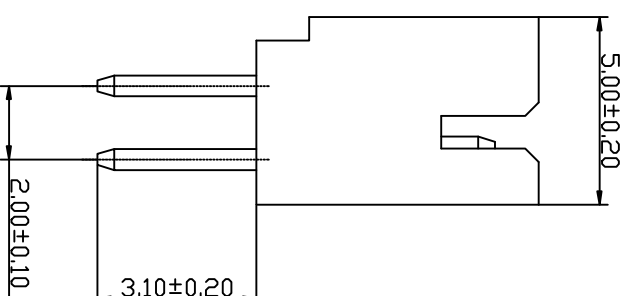
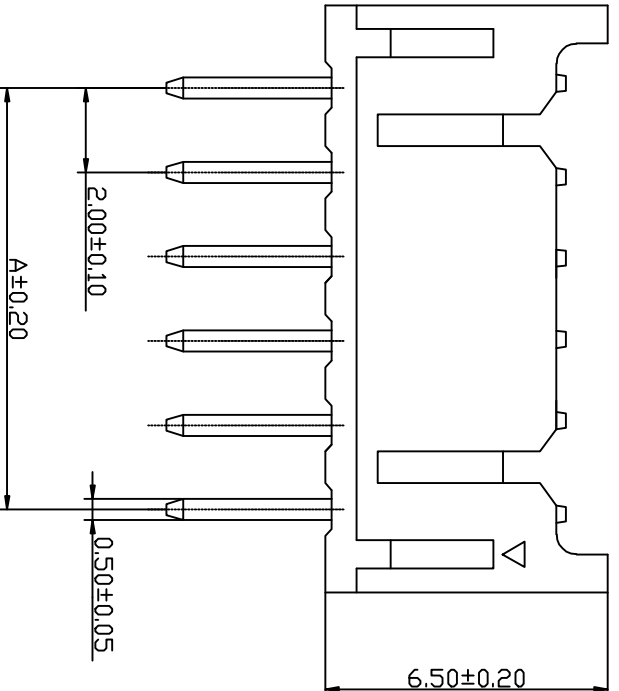
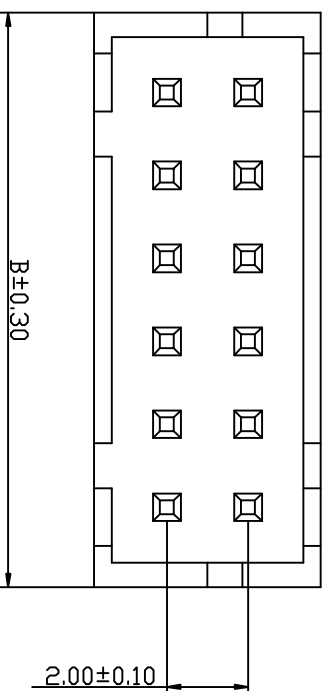

- SPECIFICATIONS**
- Voltage rating: 250V AC, DC
 - Current rating: 3A, AC, DC
 - Withstanding Voltage: 800V AC/minute
 - Insulation resistance: 1000MΩ min
 - Temperature range: -40℃~+85℃
 - Contact resistance: 10MΩ max
- WAFER
- Part No: W2005V-2*NP
 - Poles: 04-40
 - Material: Nylon 66 UL94V-0
 - Pin Material: Brass /Tin-plated

Part No	Dimensions (mm)	
	A	B
W2005V-2*02	2.00	6.00
W2005V-2*03	4.00	8.00
W2005V-2*04	6.00	10.00
W2005V-2*05	8.00	12.00
W2005V-2*06	10.00	14.00
W2005V-2*07	12.00	16.00
W2005V-2*08	14.00	18.00
W2005V-2*09	16.00	20.00
W2005V-2*10	18.00	22.00
W2005V-2*11	20.00	24.00
W2005V-2*12	22.00	26.00
W2005V-2*13	24.00	28.00
W2005V-2*14	26.00	30.00
W2005V-2*15	28.00	32.00
W2005V-2*16	30.00	34.00
W2005V-2*17	32.00	36.00
W2005V-2*18	34.00	38.00
W2005V-2*19	36.00	40.00
W2005V-2*20	38.00	42.00

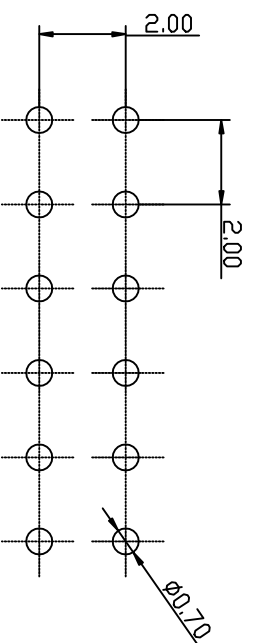

P.C.B LAYOUT

KLT 深圳市康利通电子科技有限公司

成品规格图

TOCERANCE

0±0.30

.0±0.25

.00±0.20

.000±0.015

TITLE	成品规格图		SCALE		1:1	VER No	SIZE
CHECKED BY	DATE	2016-05-03	SCALE	1:1	VER No	SIZE	
DRAWN BY	UNIT:mm				A	A4	
李国常	PART No	W2005V-2*NP					

DRAWN BY	UNIT:mm				A	A4
李国常	PART No	W2005V-2*NP				

B

C

D

E

F

1

4

B

C

E

公差表

REV	ECN NO	LOCATIONS	DESCRIPTION	DATE	CHANGER
A			新版本	2016-05-03	李国常

4

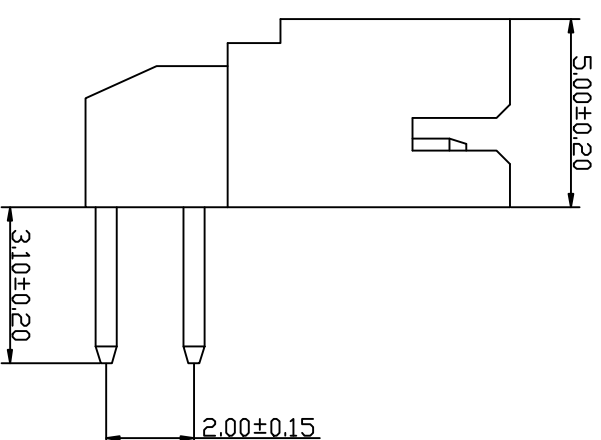
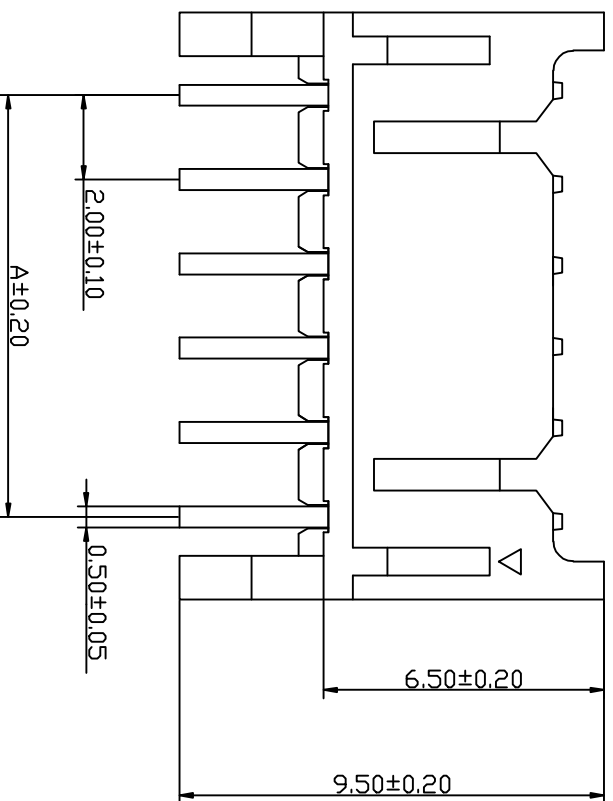
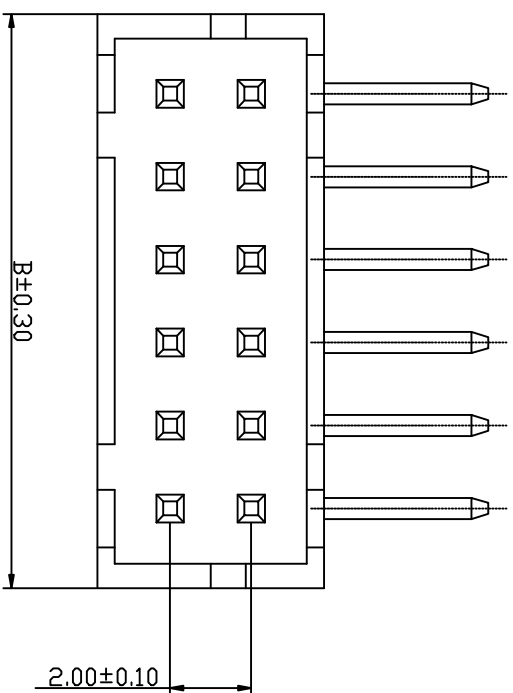

Part No	Dimensions (mm)	
	A	B
W2005R-2*02	2.00	6.00
W2005R-2*03	4.00	8.00
W2005R-2*04	6.00	10.00
W2005R-2*05	8.00	12.00
W2005R-2*06	10.00	14.00
W2005R-2*07	12.00	16.00
W2005R-2*08	14.00	18.00
W2005R-2*09	16.00	20.00
W2005R-2*10	18.00	22.00
W2005R-2*11	20.00	24.00
W2005R-2*12	22.00	26.00
W2005R-2*13	24.00	28.00
W2005R-2*14	26.00	30.00
W2005R-2*15	28.00	32.00
W2005R-2*16	30.00	34.00
W2005R-2*17	32.00	36.00
W2005R-2*18	34.00	38.00
W2005R-2*19	36.00	40.00
W2005R-2*20	38.00	42.00

- SPECIFICATIONS**
- Voltage rating: 250V AC, DC
 - Current rating: 3A, AC, DC
 - Withstanding Voltage: 800V AC/minute
 - Insulation resistance: 1000MΩ min
 - Temperature range: -40℃~+85℃
 - Contact resistance: 10MΩ max
- WAFER
- Part No: W2005R-2*NP
 - Poles: 04-40
 - Material: Nylon 66 UL94V-0
 - Pin Material: Brass /Tin-plated

TOLERANCE

0±0.30

.0±0.25

.00±0.20

.000±0.015

VER No SIZE

A A4

KLT 深圳市康利通电子科技有限公司

成品规格图

TITLE	成品规格图		SCALE	1:1	VER No	SIZE
CHECKED BY	DATE	2016-05-03	SCALE	1:1	VER No	SIZE
DRAWN BY	UNIT:mm					
李国常	PART No	W2005R-2*NP				

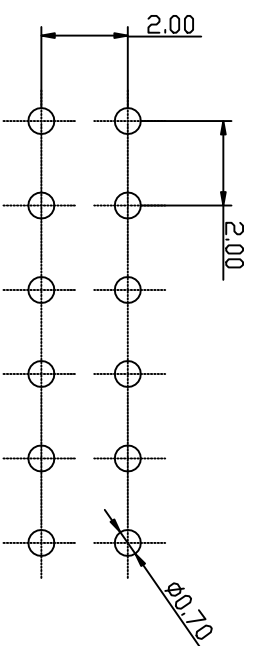

P.C.B LAYOUT

B

C

D

E

F

1

4