

B

C

E

公差表

REV	ECN NO	LOCATIONS	DESCRIPTION	DATE	CHANGER
A			新版本	2016-05-04	李国常

SPECIFICATIONS

- Voltage rating: 250V AC, DC
 - Current rating: 2A, AC, DC
 - Withstanding Voltage: 800V AC/minute
 - Insulation resistance: 1000MΩ min
 - Temperature range: -40℃~+85℃
 - Contact resistance: 20MΩ max
- HOUSING
- Part No: H2012R-NP
 - Poles: 02-16
 - Material: Nylon 66 UL94V-0

4

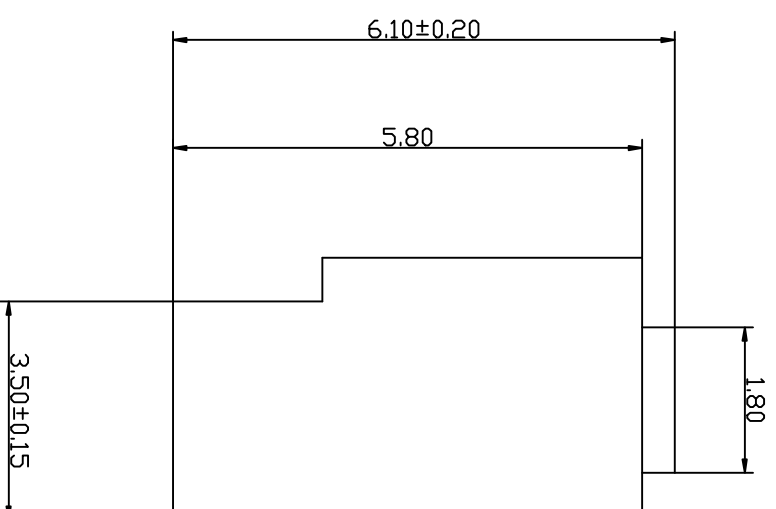
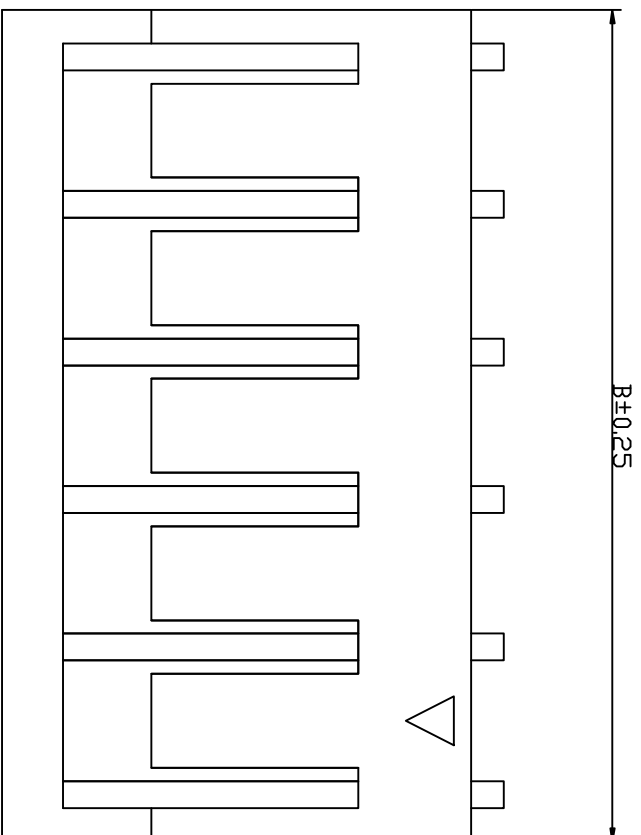

Part No	Dimensions (mm)	
	A	B
H2012R-02	2.00	5.20
H2012R-03	4.00	7.20
H2012R-04	6.00	9.20
H2012R-05	8.00	11.20
H2012R-06	10.00	13.20
H2012R-07	12.00	15.20
H2012R-08	14.00	17.20
H2012R-09	16.00	19.20
H2012R-10	18.00	21.00
H2012R-11	20.00	23.20
H2012R-12	22.00	25.20
H2012R-13	24.00	27.20
H2012R-14	26.00	29.20
H2012R-15	28.00	31.20
H2012R-16	30.00	33.20

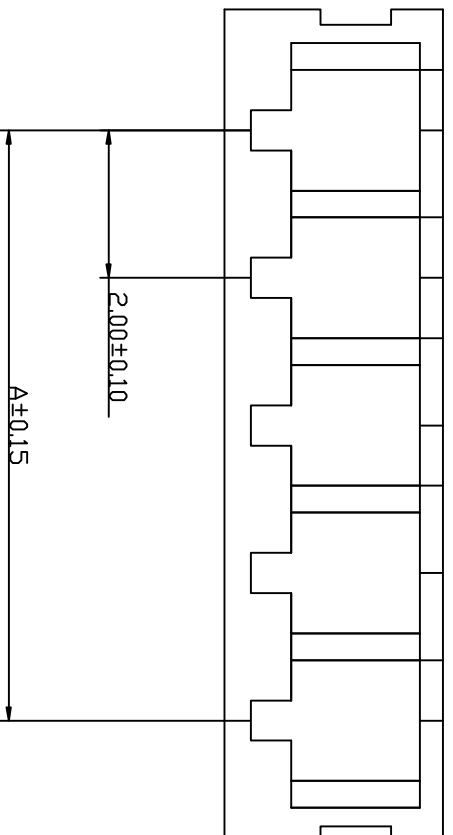

KLT 深圳市康利通电子科技有限公司

成品规格图

TOLERANCE

0±0.30

.0±0.25

.00±0.20

.000±0.015

1

4

TITLE	成品规格图		TOLERANCE	
CHECKED BY	DATE	SCALE	.00±0.25	
DRAWN BY	UNIT:mm	1:1	.00±0.20	
PART No	H2012R-NP	VER No	A	SIZE
李国常		A	A4	

B

C

D

E

F

B

C

E

公差表

REV	ECN NO	LOCATIONS	DESCRIPTION	DATE	CHANGER
A			新版本	2016-05-04	李国常

SPECIFICATIONS

- Voltage rating: 250V AC, DC
 - Current rating: 2A, AC, DC
 - Withstanding Voltage: 800V AC/minute
 - Insulation resistance: 1000MΩ min
 - Temperature range: -40℃~+85℃
 - Contact resistance: 20MΩ max
- HOUSING
- Part No: H2012-NP
 - Poles: 02-16
 - Material: Nylon 66 UL94V-0

4

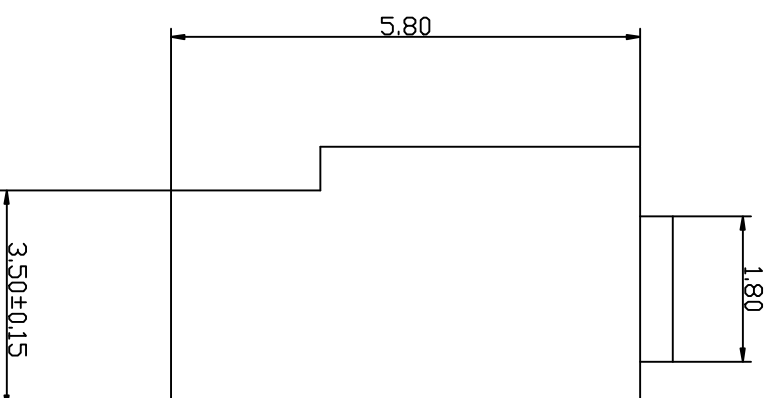
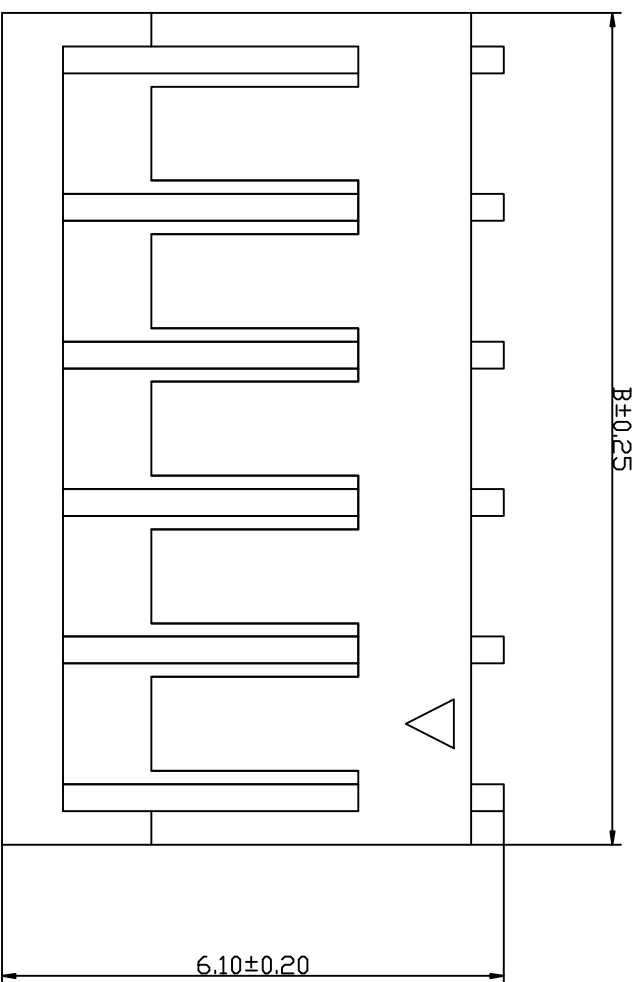

Part No	Dimensions (mm)	
	A	B
H2012-02	2.00	5.20
H2012-03	4.00	7.20
H2012-04	6.00	9.20
H2012-05	8.00	11.20
H2012-06	10.00	13.20
H2012-07	12.00	15.20
H2012-08	14.00	17.20
H2012-09	16.00	19.20
H2012-10	18.00	21.00
H2012-11	20.00	23.20
H2012-12	22.00	25.20
H2012-13	24.00	27.20
H2012-14	26.00	29.20
H2012-15	28.00	31.20
H2012-16	30.00	33.20

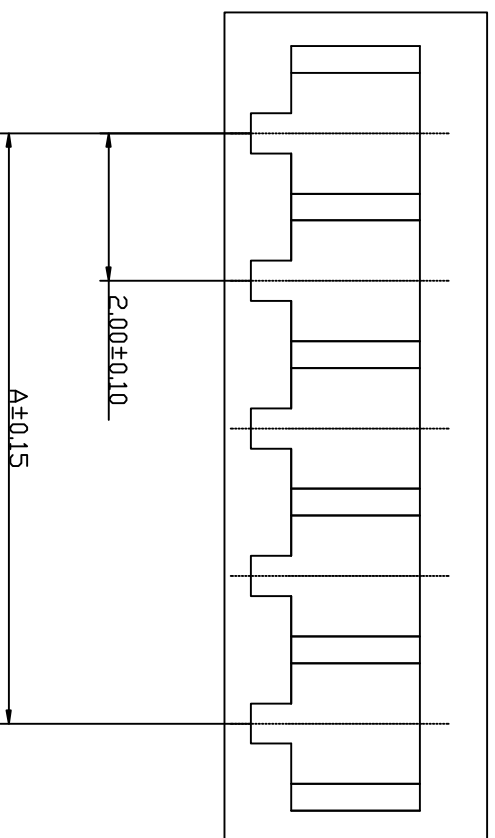

KLT 深圳市康利通电子科技有限公司

成品规格图

Tolerance

0±0.30

.0±0.25

.00±0.20

.000±0.015

TITLE	成品规格图		Tolerance	
CHECKED BY	DATE	SCALE	VER No	SIZE
	2016-05-04	1:1	A	A4
DRAWN BY	UNIT:mm		H2012-NP	
李国常	PART No			

B

C

D

E

F

1

4

B

C

E

公差表

REV	ECN NO	LOCATIONS	DESCRIPTION	DATE	CHANGER
A			新版本	2016-05-04	李国常

SPECIFICATIONS

- Voltage rating: 250V AC, DC
- Current rating: 2A, AC, DC
- Withstanding Voltage: 800V AC/minute
- Insulation resistance: 1000MΩ min
- Temperature range: -40℃~+85℃
- Contact resistance: 20MΩ max

TERMINAL

- Part No: T2012RBT
- Applicable wire: AWG#24-#30
- Material: Brass
- Finish: Tin plated

4

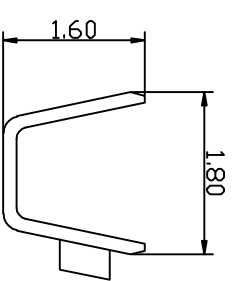
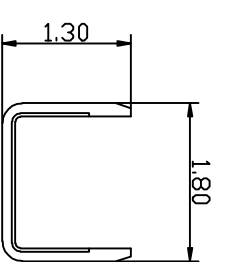
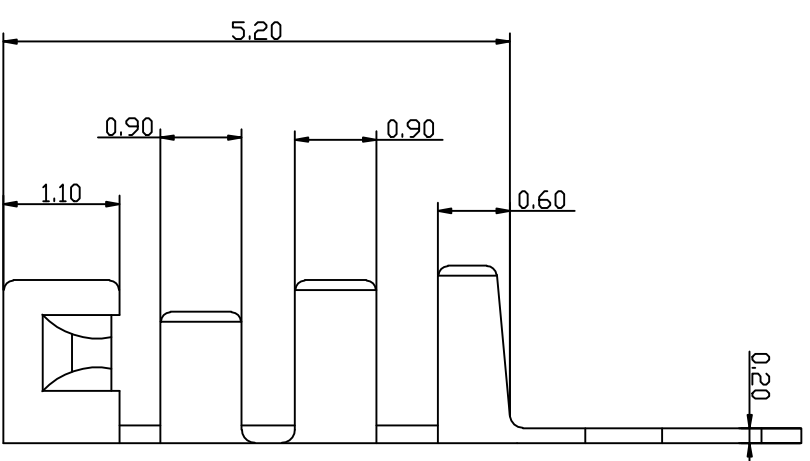
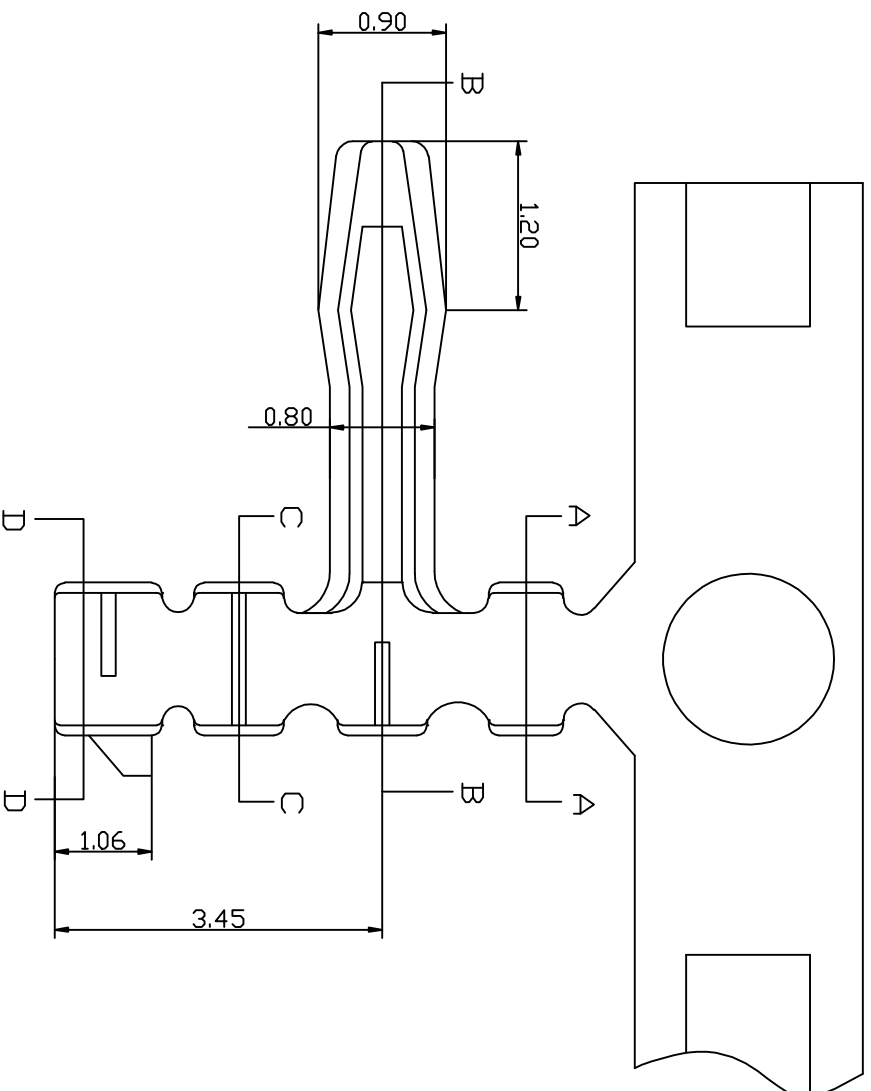

SEC: C-C

SEC: D-D

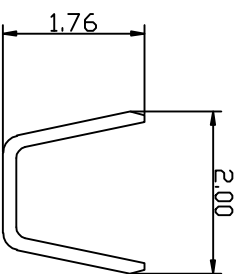

SEC: A-A

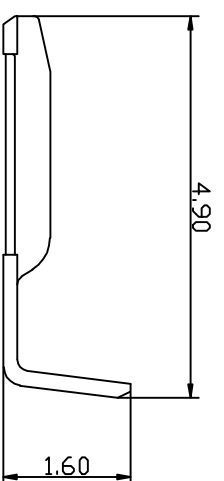

SEC: B-B

KLT 深圳市康利通电子科技有限公司

成品规格图

TO CERANCE

0±0.30

.0±0.25

.00±0.20

.000±0.015

TITLE	DATE	SCALE	VER No	SIZE
CHECKED BY	2016-05-04	1:1	A	A4
DRAWN BY	UNIT:mm			
PART No	T2012RBT			

李国常

PART No

T2012RBT

B

C

D

E

F

1

4

B

C

E

公差表

REV	ECN NO	LOCATIONS	DESCRIPTION	DATE	CHANGER
A			新版本	2016-05-04	李国常

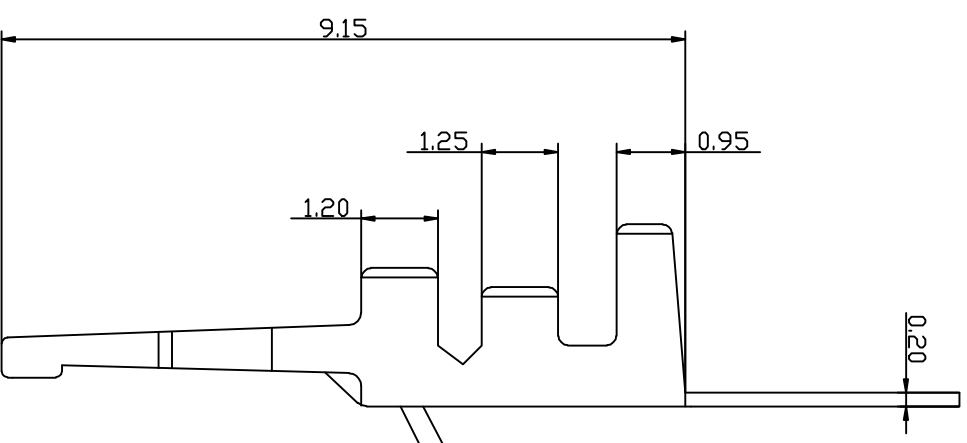
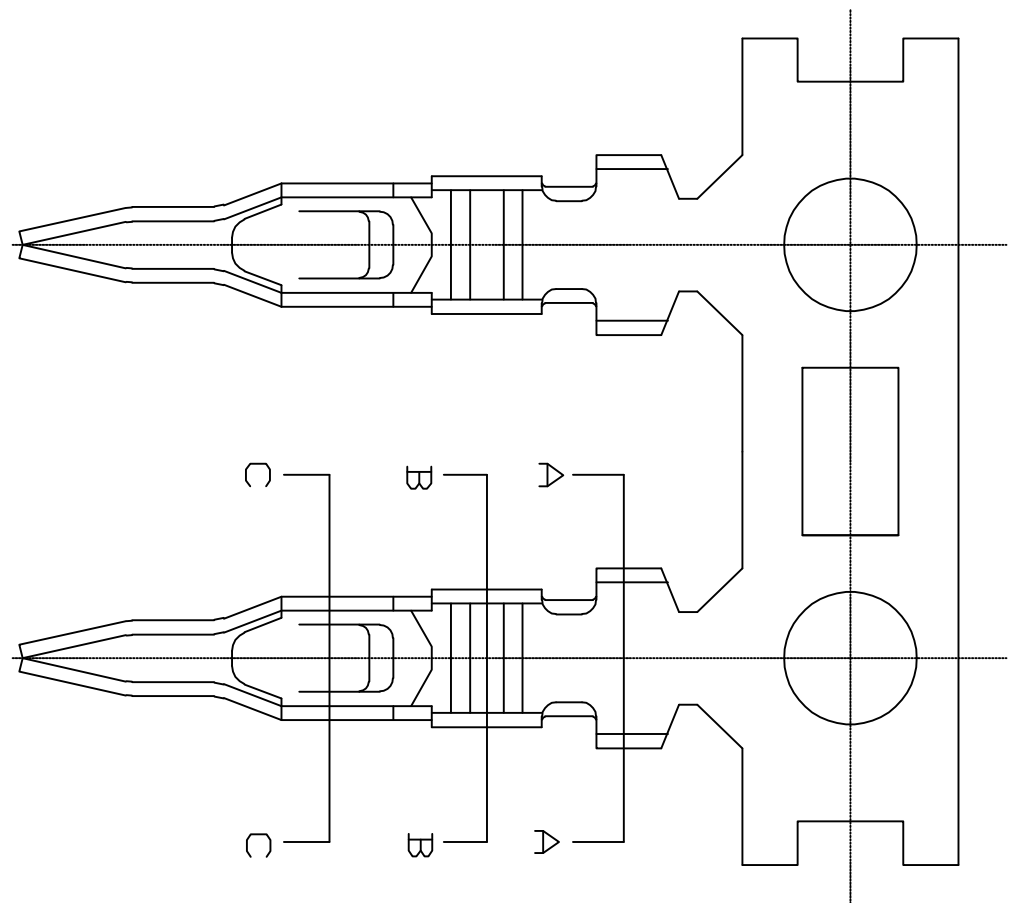

SPECIFICATIONS

- Voltage rating: 250V AC, DC
- Current rating: 2A, AC, DC
- Withstanding Voltage: 800V AC/minute
- Insulation resistance: 1000MΩ min
- Temperature range: -40℃~+85℃
- Contact resistance: 20MΩ max

TERMINAL

- Part No: T2012BT
- Applicable wire: AWG#24-#30
- Material: Brass
- Finish: Tin plated

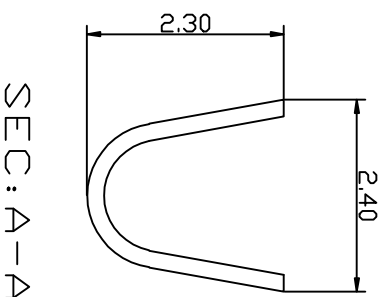

SEC: A-A

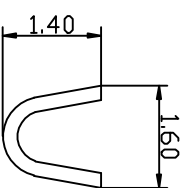

SEC: B-B

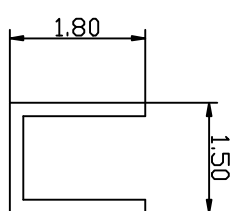

SEC: C-C

KLT 深圳市康利通电子科技有限公司

成品规格图

Tolerance

0±0.30

.0±0.25

.00±0.20

.000±0.015

VER No SIZE

A A4

1

4

B

C

D

E

F

TITLE	成品规格图		Tolerance	
CHECKED BY	DATE	SCALE	0±0.30	
DRAWN BY	UNIT:mm	1:1	.0±0.25	
李国常	PART No	T2012BT	.00±0.20	
			.000±0.015	
			VER No SIZE	
			A A4	