

B

C

E

公差表

REV	ECN NO	LOCATIONS	DESCRIPTION	DATE	CHANGER
A			新版本	2016-05-10	李国常

SPECIFICATIONS

- Voltage rating: 125V AC, DC
- Current rating: 2A, AC, DC
- Withstanding Voltage: 800V AC/minute
- Insulation resistance: 1000MΩ min
- Temperature range: -40℃~+85℃
- Contact resistance: 20MΩ max

HOUSING

- Part No: H2007-NP
- Poles: 02-16
- Material: Nylon 66 UL94V-0

4

4

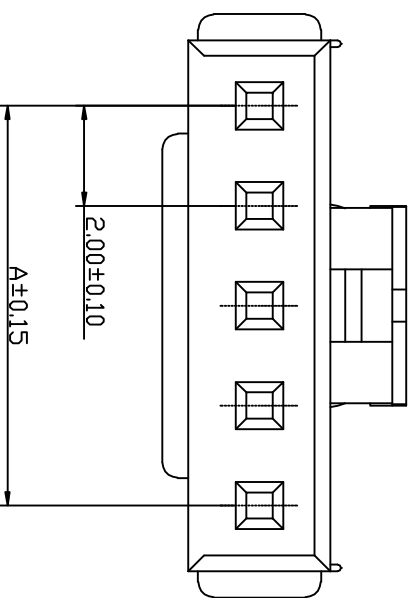
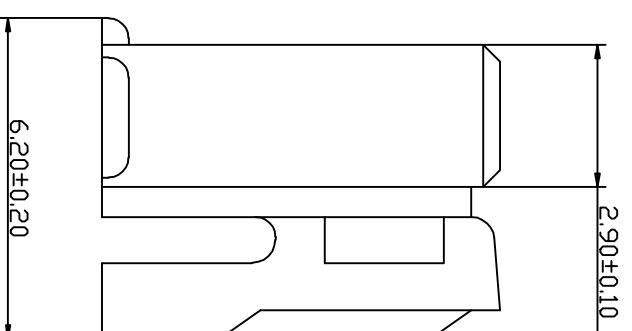
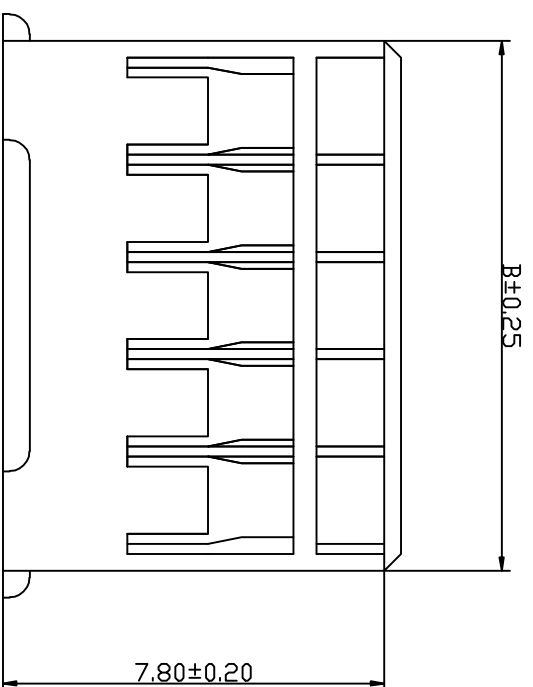

Part No	Dimensions (mm)	
	A	B
H2007-02	2.00	4.60
H2007-03	4.00	6.60
H2007-04	6.00	8.60
H2007-05	8.00	10.60
H2007-06	10.00	12.60
H2007-07	12.00	14.60
H2007-08	14.00	16.60
H2007-09	16.00	18.60
H2007-10	18.00	20.60
H2007-11	20.00	22.60
H2007-12	22.00	24.60
H2007-13	24.00	26.60
H2007-14	26.00	28.60
H2007-15	28.00	30.60
H2007-16	30.00	32.60

KLIT 深圳市康利通电子科技有限公司

成品规格图

TOLERANCE

0±0.30

.0±0.25

.00±0.20

.000±0.015

1

TITLE	成品规格图		TOLERANCE	
CHECKED BY	DATE	SCALE	VER No	SIZE
	2016-05-10	1:1	A	A4
DRAWN BY	UNIT:mm			
李国常	PART No	H2007-NP		

B

C

D

E

F

B

C

E

公差表

REV	ECN NO	LOCATIONS	DESCRIPTION	DATE	CHANGER
A			新版本	2016-05-10	李国常

4

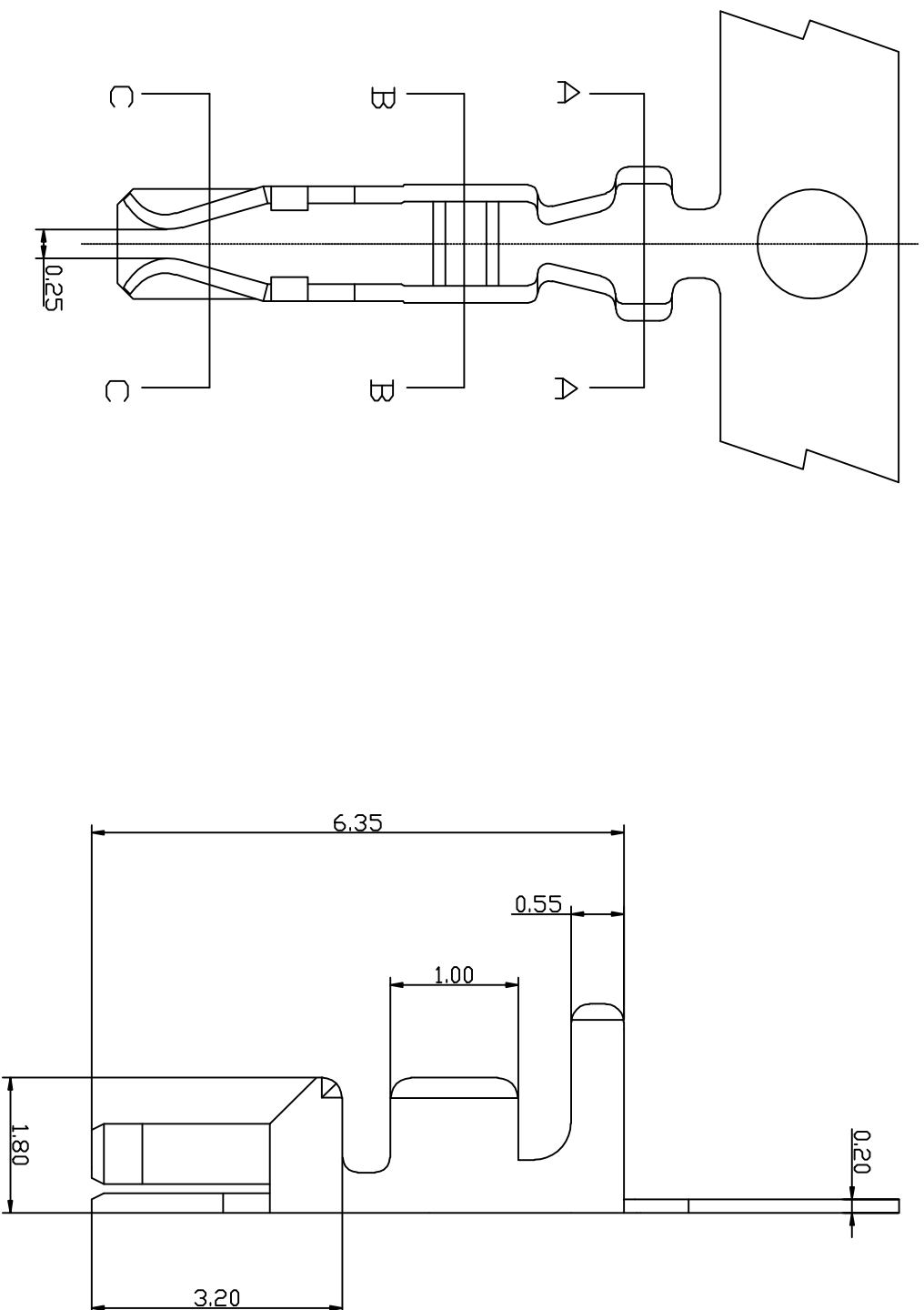

- SPECIFICATIONS**
- Voltage rating: 250V AC, DC
 - Current rating: 3A, AC, DC
 - Withstanding Voltage: 800V AC/minute
 - Insulation resistance: 1000MΩ min
 - Temperature range: -40℃~+85℃
 - Contact resistance: 20MΩ max
- TERMINAL**
- Part No: T2007PT
 - Applicable wire: AWG#22-#30
 - Material: Phosphor Bronze
 - Finish: Tin plated

4

SEC: A-A

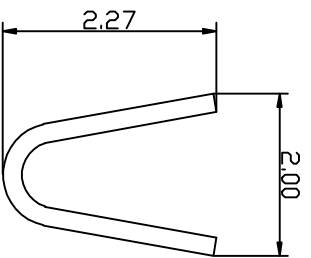

SEC: B-B

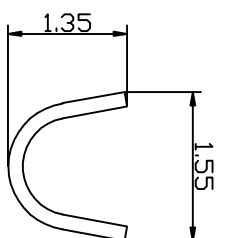

SEC: C-C

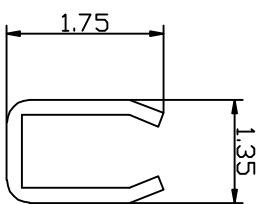

KLT 深圳市康利通电子科技有限公司

成品规格图

Tolerance

0±0.30

.0±0.25

.00±0.20

.000±0.015

1

TITLE	DATE	SCALE	VER No	SIZE
CHECKED BY	2016-05-10	1:1	A	A4
DRAWN BY	UNIT:mm			
李国常	PART No	T2007PT		

B

C

D

E

F

B

C

E

公差表

REV	ECN NO	LOCATIONS	DESCRIPTION	DATE	CHANGER
A			新版本	2016-05-10	李国常

4

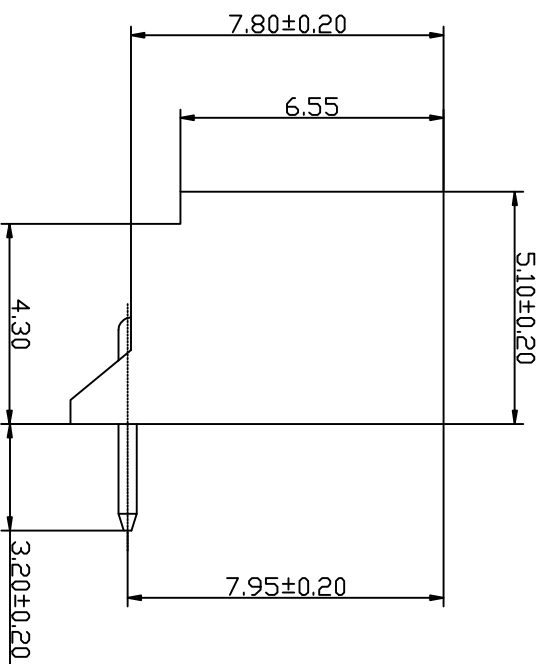
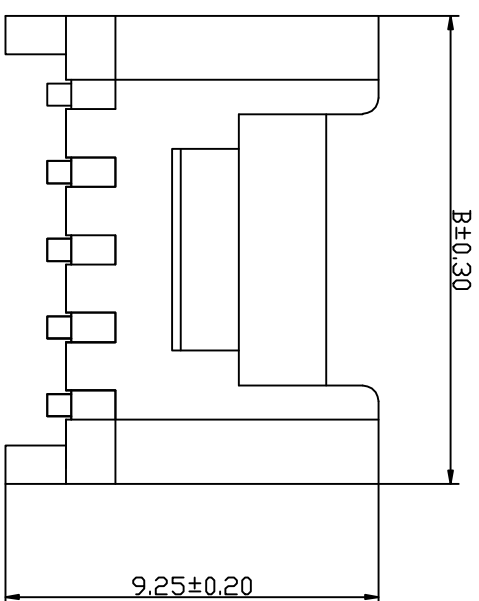
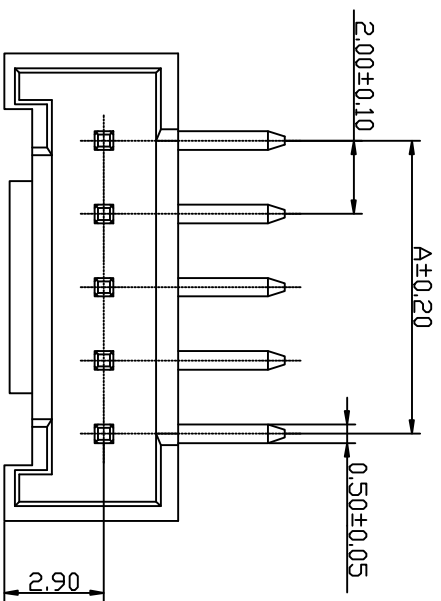

Part No	Dimensions (mm)	
	A	B
V2007R-02	2.00	6.00
V2007R-03	4.00	8.00
V2007R-04	6.00	10.00
V2007R-05	8.00	12.00
V2007R-06	10.00	14.00
V2007R-07	12.00	16.00
V2007R-08	14.00	18.00
V2007R-09	16.00	20.00
V2007R-10	18.00	22.00
V2007R-11	20.00	24.00
V2007R-12	22.00	26.00
V2007R-13	24.00	28.00
V2007R-14	26.00	30.00
V2007R-15	28.00	32.00
V2007R-16	30.00	34.00

- SPECIFICATIONS**
- Voltage rating: 250V AC, DC
 - Current rating: 3A, AC, DC
 - Withstanding Voltage: 1000V AC/minute
 - Insulation resistance: 1000MΩ min
 - Temperature range: -40℃~+85℃
 - Contact resistance: 20MΩ max
- WAFER
- Part No: W2007R-NP
 - Poles: 02-16
 - Material: Nylon 66 UL94V-0
 - Pin Material: Brass /Tin-plated

4

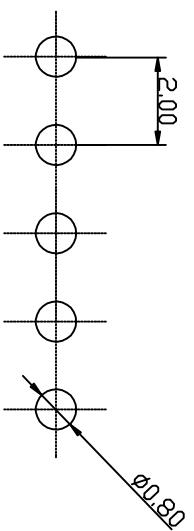

P.C.B LAYOUT

KLT 深圳市康利通电子科技有限公司

成品规格图

TOLERANCE

0±0.30

.0±0.25

.00±0.20

.000±0.015

VER No SIZE

A A4

TITLE	成品规格图		TOLERANCE	
CHECKED BY	DATE	SCALE	VER No	SIZE
DRAWN BY	UNIT:mm	1:1	A	A4
李国常	2016-05-10			
PART No	W2007R-NP			

B

C

D

E

F

1

B

C

E

公差表

REV	ECN NO	LOCATIONS	DESCRIPTION	DATE	CHANGER
A			新版本	2016-05-10	李国常

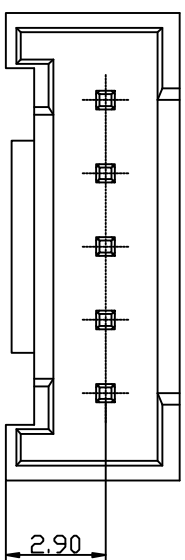

4

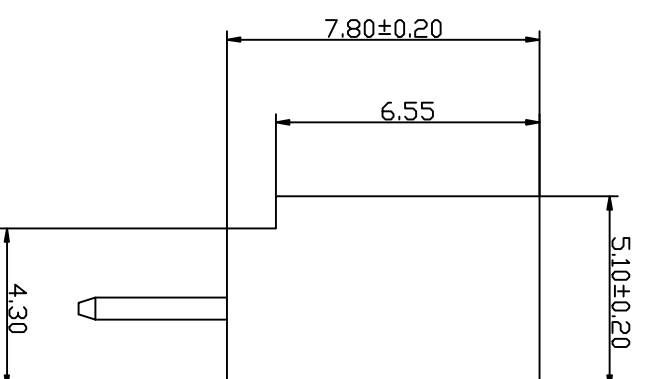
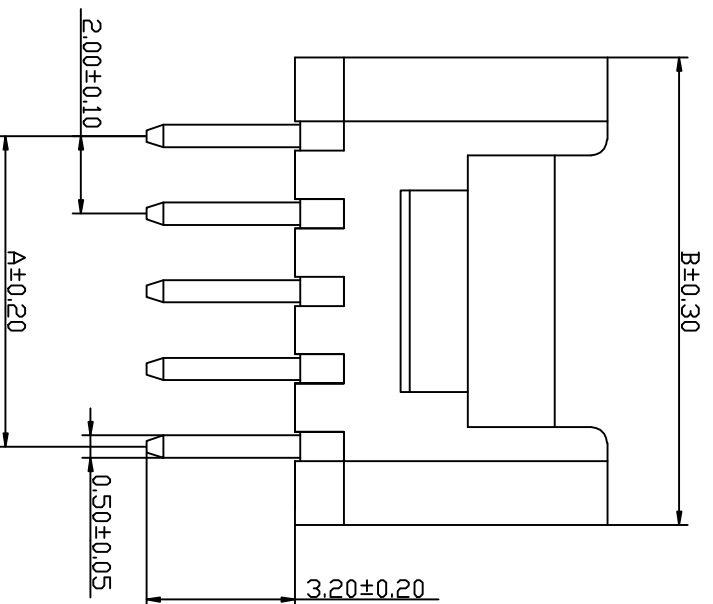

Part No	Dimensions (mm)	
	A	B
W2007V-02	2.00	6.00
W2007V-03	4.00	8.00
W2007V-04	6.00	10.00
W2007V-05	8.00	12.00
W2007V-06	10.00	14.00
W2007V-07	12.00	16.00
W2007V-08	14.00	18.00
W2007V-09	16.00	20.00
W2007V-10	18.00	22.00
W2007V-11	20.00	24.00
W2007V-12	22.00	26.00
W2007V-13	24.00	28.00
W2007V-14	26.00	30.00
W2007V-15	28.00	32.00
W2007V-16	30.00	34.00

- SPECIFICATIONS**
- Voltage rating: 250V AC, DC
 - Current rating: 3A, AC, DC
 - Withstanding Voltage: 1000V AC/minute
 - Insulation resistance: 1000MΩ min
 - Temperature range: -40℃~+85℃
 - Contact resistance: 20MΩ max
- WAFER**
- Part No: W2007V-NP
 - Poles: 02-16
 - Material: Nylon 66 UL94V-0
 - Pin Material: Brass / Tin-plated

4

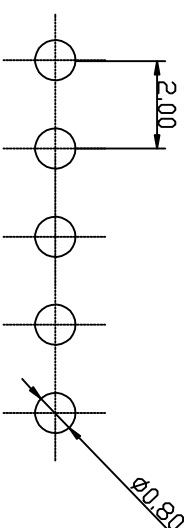

P.C.B LAYOUT

B

C

D

E

F

KLT 深圳市康利通电子科技有限公司

TITLE

成品规格图

TOLERANCE

0±0.30

.0±0.25

.00±0.20

.000±0.015

CHECKED BY

DATE

SCALE

2016-05-10

1:1

VER No

SIZE

DRAWN BY

UNIT:mm

1:1

A

A4

李国常

PART No

W2007V-NP

1