

B

C

E

公差表

REV	ECN NO	LOCATIONS	DESCRIPTION	DATE	CHANGER
A			新版本	2016-05-28	李国常

SPECIFICATIONS

- Voltage rating: 250V AC, DC
 - Current rating: 5A, AC, DC
 - Withstanding Voltage: 1500V AC/minute
 - Insulation resistance: 1000MΩ min
 - Temperature range: -40℃~+85℃
 - Contact resistance: 10MΩ max
- HOUSING**
- Part No: H3025-2*NP
 - Poles: 02-24
 - Material: Nylon 66 UL94V-2

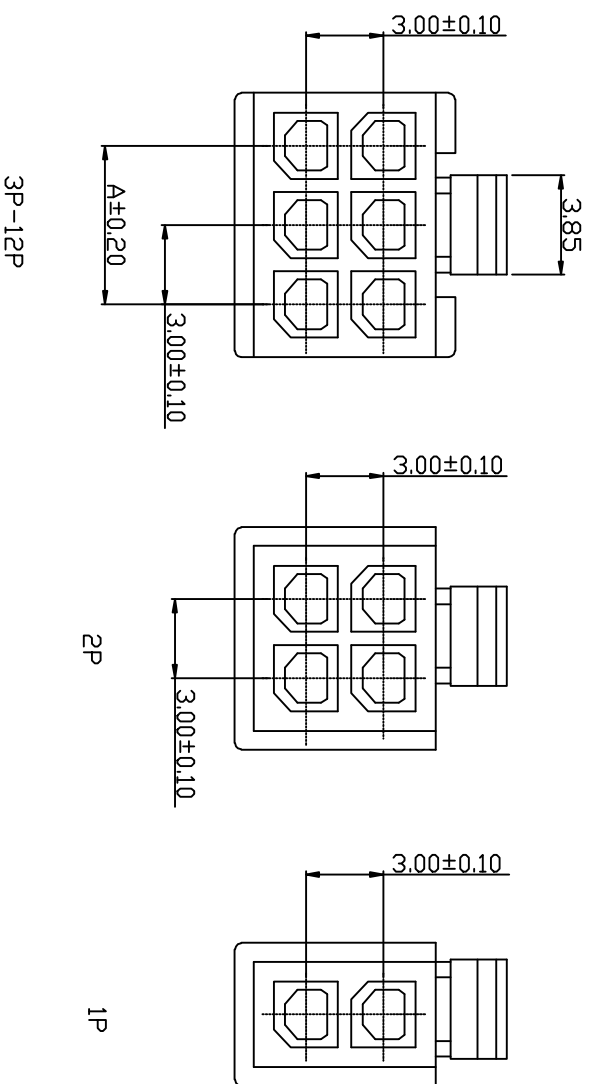
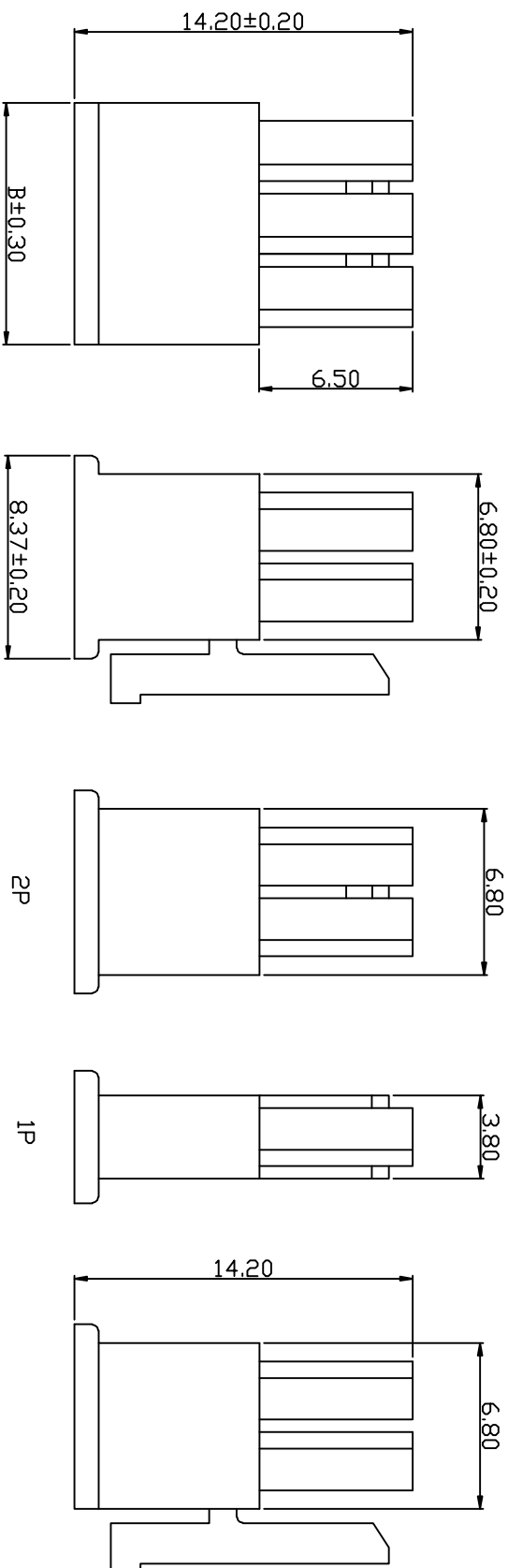

Part No	Dimensions (mm)	
	A	B
H3025-2*01	—	3.80
H3025-2*02	3.00	6.80
H3025-2*03	6.00	9.80
H3025-2*04	9.00	12.80
H3025-2*05	12.00	15.80
H3025-2*06	15.00	18.80
H3025-2*07	18.00	21.80
H3025-2*08	21.00	24.80
H3025-2*09	24.00	27.80
H3025-2*10	27.00	30.80
H3025-2*11	30.00	33.80
H3025-2*12	33.00	36.80

KLT 深圳市康利通电子科技有限公司

成品规格图

TOLERANCE

0±0.30

.0±0.25

.00±0.20

.000±0.015

TITLE	成品规格图		TOLERANCE	
CHECKED BY	DATE	SCALE	VER No	SIZE
DRAWN BY	UNIT:mm	1:1	A	A4
李国常	2016-05-28			
PART No	H3025-2*NP			

4

4

B

C

D

E

F

1

B

C

E

公差表

REV	ECN NO	LOCATIONS	DESCRIPTION	DATE	CHANGER
A			新版本	2016-05-28	李国常

SPECIFICATIONS

- Voltage rating: 250V AC, DC
- Current rating: 5A, AC, DC
- Withstanding Voltage: 1500V AC/minute
- Insulation resistance: 1000MΩ min
- Temperature range: -40℃~+85℃
- Contact resistance: 10MΩ max

HOUSING

- Part No: H3025-NP
- Poles: 02-12
- Material: Nylon 66 UL94V-2

4

4

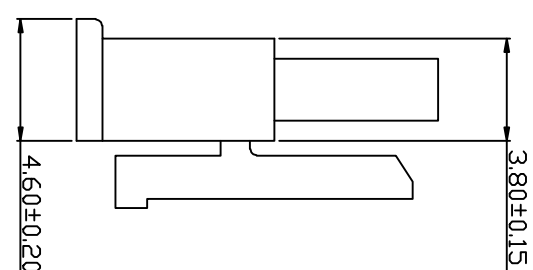
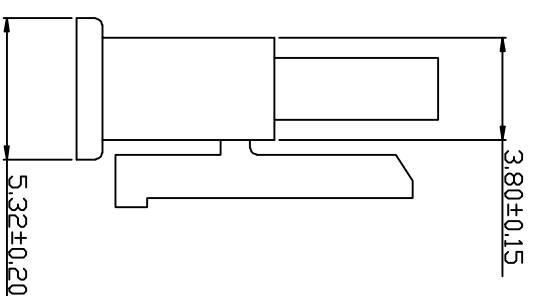
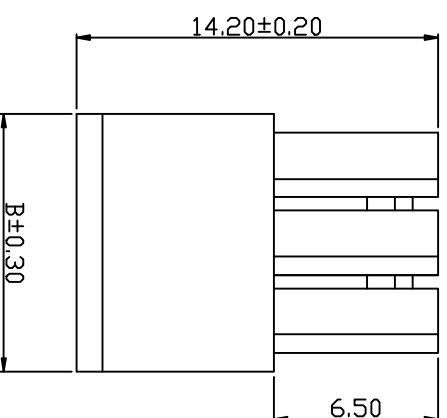

Part No	Dimensions (mm)	
	A	B
H3025-02	3.00	6.80
H3025-03	6.00	9.80
H3025-04	9.00	12.80
H3025-05	12.00	15.80
H3025-06	15.00	18.80
H3025-07	18.00	21.80
H3025-08	21.00	24.80
H3025-09	24.00	27.80
H3025-10	27.00	30.80
H3025-11	30.00	33.80
H3025-12	33.00	36.80

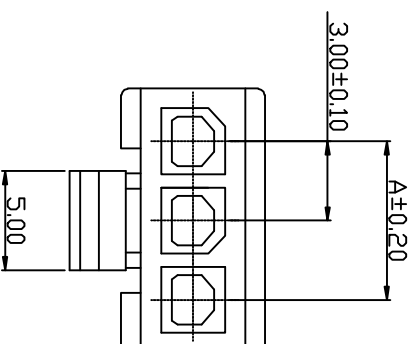

KLT 深圳市康利通电子科技有限公司

成品规格图

TOLERANCE

0±0.30

.0±0.25

.00±0.20

.000±0.015

TITLE	成品规格图		TOLERANCE	
CHECKED BY	DATE	SCALE	VER No	SIZE
	2016-05-28	1:1	A	A4

DRAWN BY	UNIT:mm	PART No	
李国常		H3025-NP	

B

C

D

E

F

1

B

C

E

公差表

REV	ECN NO	LOCATIONS	DESCRIPTION	DATE	CHANGER
A			新版本	2016-05-28	李国常

4

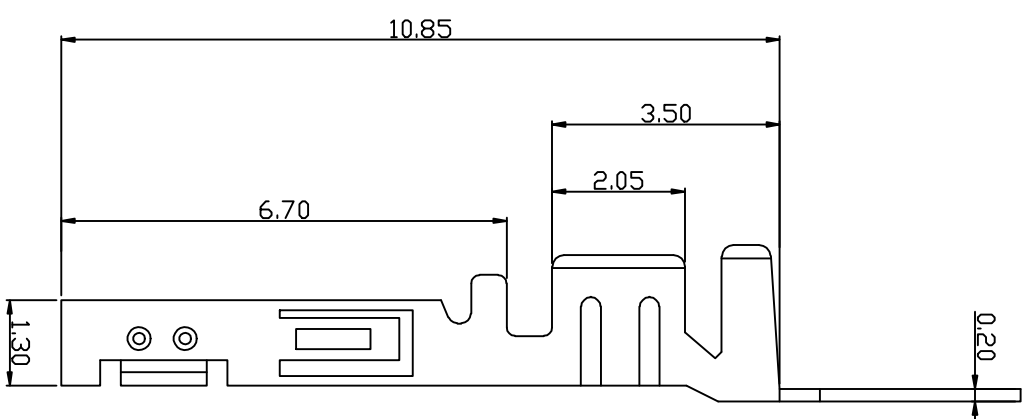
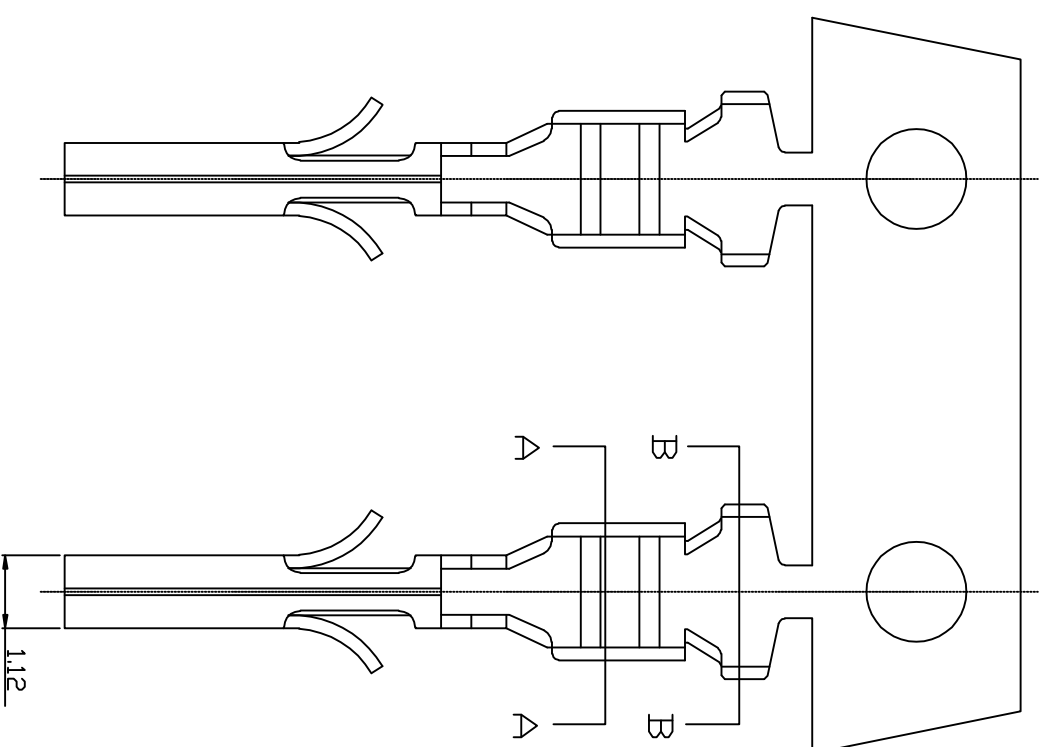

SPECIFICATIONS

- Voltage rating: 250V AC, DC
- Current rating: 5A, AC, DC
- Withstanding Voltage: 1500V AC/minute
- Insulation resistance: 1000MΩ min
- Temperature range: -40℃~+85℃
- Contact resistance: 10MΩ max

TERMINAL

- Part No: T3030PT
- Applicable wire: AWG#20-#24
- Material: Phosphor Bronze
- Finish: Tin plated

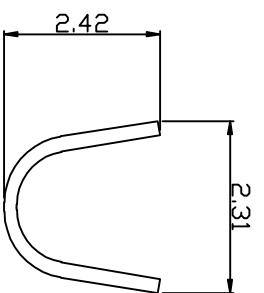

SEC: A-A

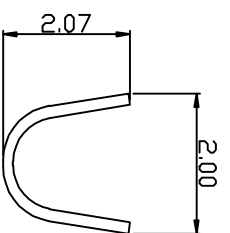

SEC: B-B

KLT 深圳市康利通电子科技有限公司

TITLE

成品规格图

TOLERANCE

0±0.30

.0±0.25

.00±0.20

.000±0.015

CHECKED BY

DATE

SCALE

2016-05-28

1:1

VER No

SIZE

DRAWN BY

UNIT:mm

李国常

A

A4

李国常

PART No

T3030PT

B

C

D

E

F

1

4