

B

C

E

公差表

| REV | ECN NO | LOCATIONS | DESCRIPTION | DATE       | CHANGER |
|-----|--------|-----------|-------------|------------|---------|
| A   |        |           | 新版本         | 2016-05-07 | 李国常     |

**SPECIFICATIONS**

- Voltage rating: 250V AC, DC
- Current rating: 2A, AC, DC
- Withstanding Voltage: 800V AC/minute
- Insulation resistance: 1000MΩ min
- Temperature range: -40℃~+85℃
- Contact resistance: 30MΩ max

**HOUSING**

- Part No: H2011-2\*NP
- Poles: 04-40
- Material: Nylon 66 UL94V-0

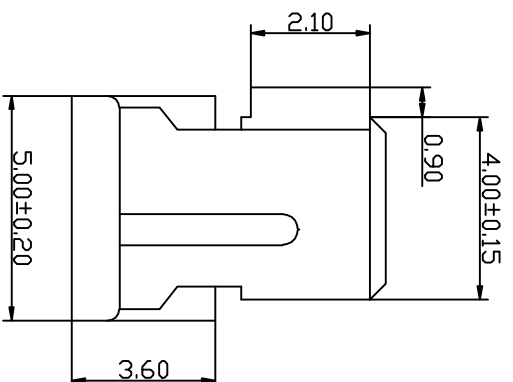
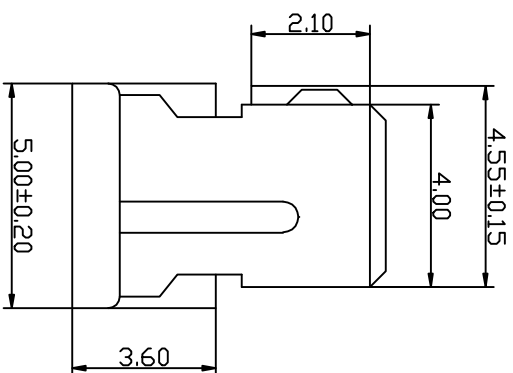
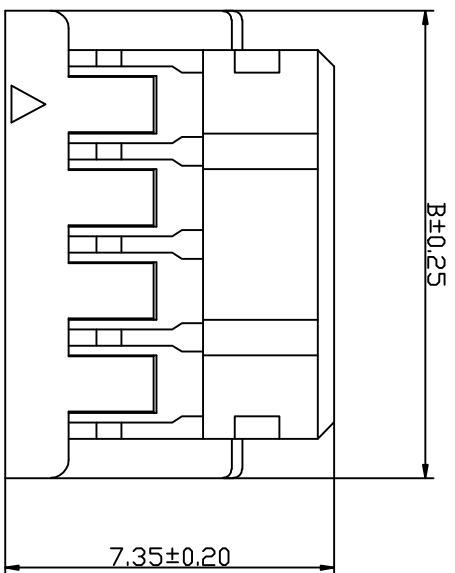

2011-2\*NP  
Type 1

2011S-2\*NP  
Type 2

| Part No    | Dimensions (mm) |       |
|------------|-----------------|-------|
|            | A               | B     |
| H2011-2*02 | 2.00            | 6.00  |
| H2011-2*03 | 4.00            | 8.00  |
| H2011-2*04 | 6.00            | 10.00 |
| H2011-2*05 | 8.00            | 12.00 |
| H2011-2*06 | 10.00           | 14.00 |
| H2011-2*07 | 12.00           | 16.00 |
| H2011-2*08 | 14.00           | 18.00 |
| H2011-2*09 | 16.00           | 20.00 |
| H2011-2*10 | 18.00           | 22.00 |
| H2011-2*11 | 20.00           | 24.00 |
| H2011-2*12 | 22.00           | 26.00 |
| H2011-2*13 | 24.00           | 28.00 |
| H2011-2*14 | 26.00           | 30.00 |
| H2011-2*15 | 28.00           | 32.00 |
| H2011-2*16 | 30.00           | 34.00 |
| H2011-2*17 | 32.00           | 36.00 |
| H2011-2*18 | 34.00           | 38.00 |
| H2011-2*19 | 36.00           | 40.00 |
| H2011-2*20 | 38.00           | 42.00 |

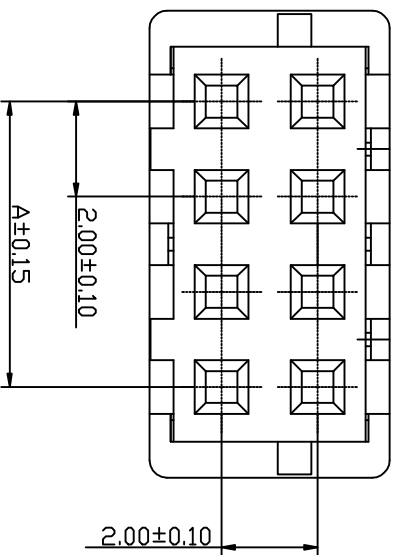

**KLT** 深圳市康利通电子科技有限公司

成品规格图

TOLERANCE

0±0.30

.0±0.25

.00±0.20

.000±0.015

|            |            |            |           |      |
|------------|------------|------------|-----------|------|
| TITLE      | 成品规格图      |            | TOLERANCE |      |
| CHECKED BY | DATE       | SCALE      | VER No    | SIZE |
|            | 2016-05-07 | 1:1        | A         | A4   |
| DRAWN BY   | UNIT:mm    |            |           |      |
| 李国常        | PART No    | H2011-2*NP |           |      |

4

4

B

C

D

E

F

1

B

C

E

公差表

| REV | ECN NO | LOCATIONS | DESCRIPTION | DATE       | CHANGER |
|-----|--------|-----------|-------------|------------|---------|
| A   |        |           | 新版本         | 2016-05-07 | 李国常     |

4

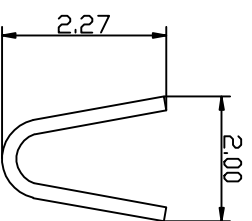
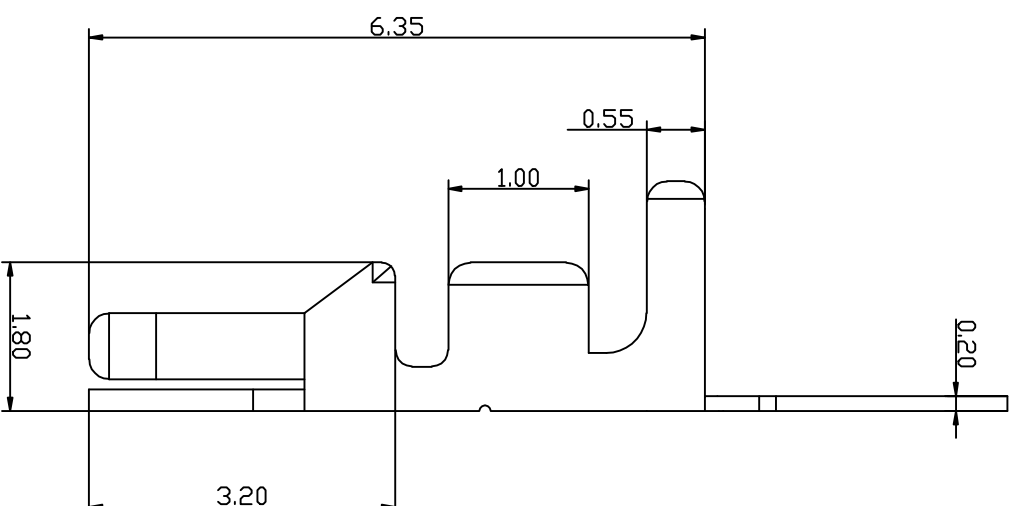
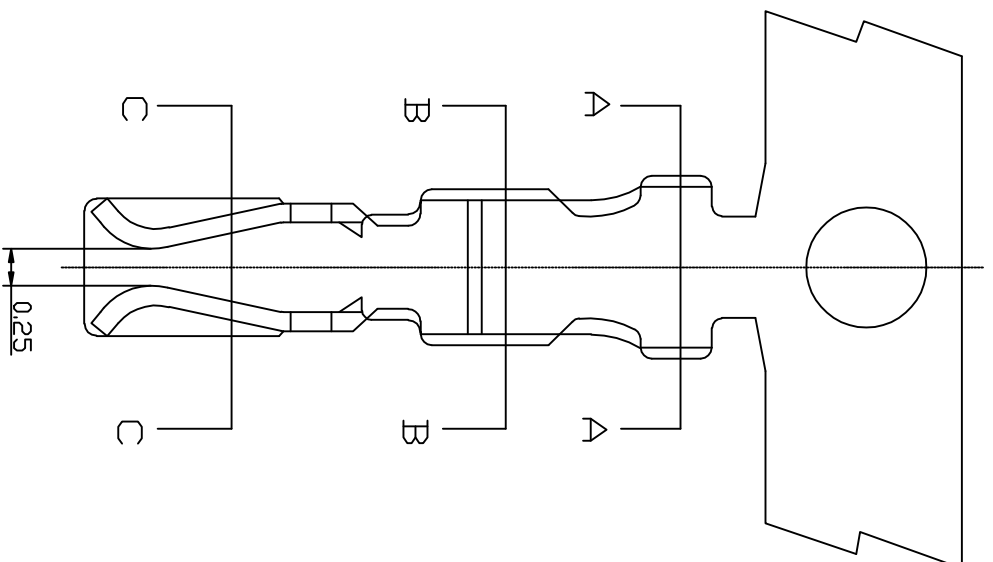

SEC: A-A

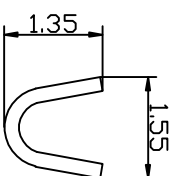

SEC: B-B

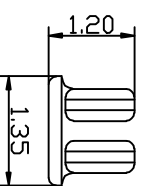

SEC: C-C

**KLT** 深圳市康利通电子科技有限公司

成品规格图

Tolerance

0±0.30

.0±0.25

.00±0.20

.000±0.015

1

|            |            |       |           |      |
|------------|------------|-------|-----------|------|
| TITLE      | 成品规格图      |       | Tolerance |      |
| CHECKED BY | DATE       | SCALE | VER No    | SIZE |
|            | 2016-05-07 | 1:1   | A         | A4   |
| DRAWN BY   | UNIT:mm    |       | T2011PT   |      |
| 李国常        | PART No    |       |           |      |

B

C

D

E

F

4