

B

C

E

公差表

REV	ECN NO	LOCATIONS	DESCRIPTION	DATE	CHANGER
A			新版本	2016-05-09	李国常

SPECIFICATIONS

- Voltage rating: 125V AC, DC
- Current rating: 2A, AC, DC
- Withstanding Voltage: 800V AC/minute
- Insulation resistance: 1000MΩ min
- Temperature range: -40℃~+85℃
- Contact resistance: 20MΩ max

HOUSING

- Part No: H2002-NP
- Poles: 02-15
- Material: Nylon 66 UL94V-0

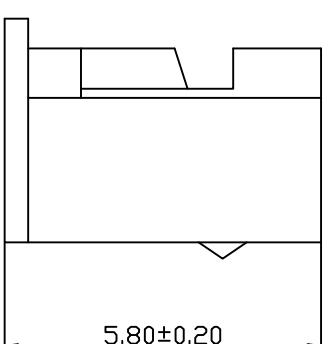
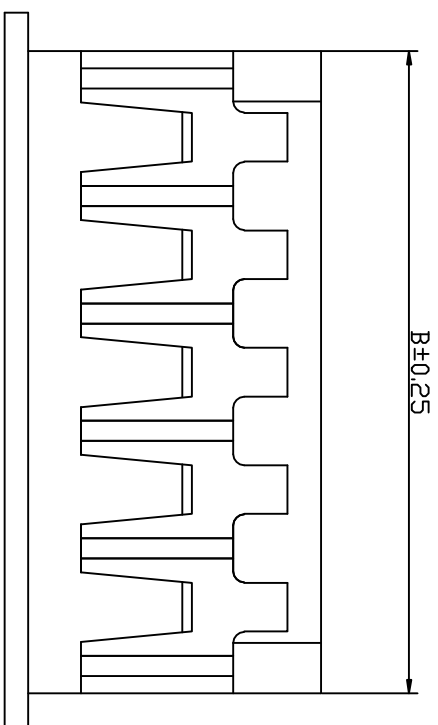

Part No	Dimensions (mm)	
	A	B
H2002-02	2.00	4.90
H2002-03	4.00	6.90
H2002-04	6.00	8.90
H2002-05	8.00	10.90
H2002-06	10.00	12.90
H2002-07	12.00	14.90
H2002-08	14.00	16.90
H2002-09	16.00	18.90
H2002-10	18.00	20.90
H2002-11	20.00	22.90
H2002-12	22.00	24.90
H2002-13	24.00	26.90
H2002-14	26.00	28.90
H2002-15	28.00	30.90

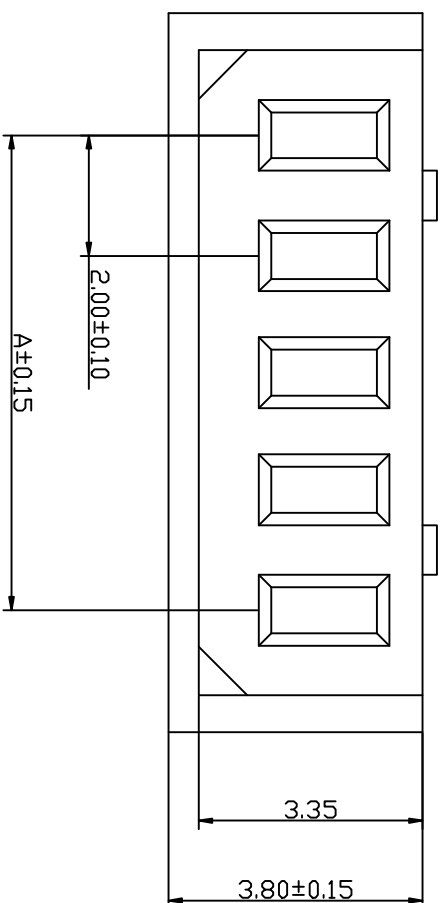

KLT 深圳市康利通电子科技有限公司

TOLERANCE

0±0.30

.0±0.25

.00±0.20

.000±0.015

TITLE	成品规格图		SCALE		1:1	VER No	A	SIZE	A4
CHECKED BY	DATE	2016-05-09	SCALE	1:1	VER No	A	SIZE	A4	
DRAWN BY	UNIT:mm	李国常	DRAWN BY		李国常	UNIT:mm		李国常	

PART No	H2002-NP	
---------	----------	--

4

4

B

C

D

E

F

1

B

C

E

公差表

REV	ECN NO	LOCATIONS	DESCRIPTION	DATE	CHANGER
A			新版本	2016-05-09	李国常

SPECIFICATIONS

- Voltage rating: 125V AC, DC
- Current rating: 2A, AC, DC
- Withstanding Voltage: 800V AC/minute
- Insulation resistance: 1000MΩ min
- Temperature range: -40℃~+85℃
- Contact resistance: 20MΩ max

TERMINAL

- Part No: T2002PT
- Applicable wire: AWG#24-#30
- Material: Phosphor Bronze
- Finish: Tin plated

4

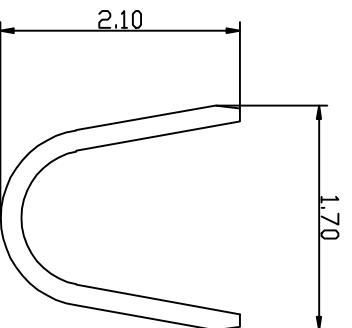
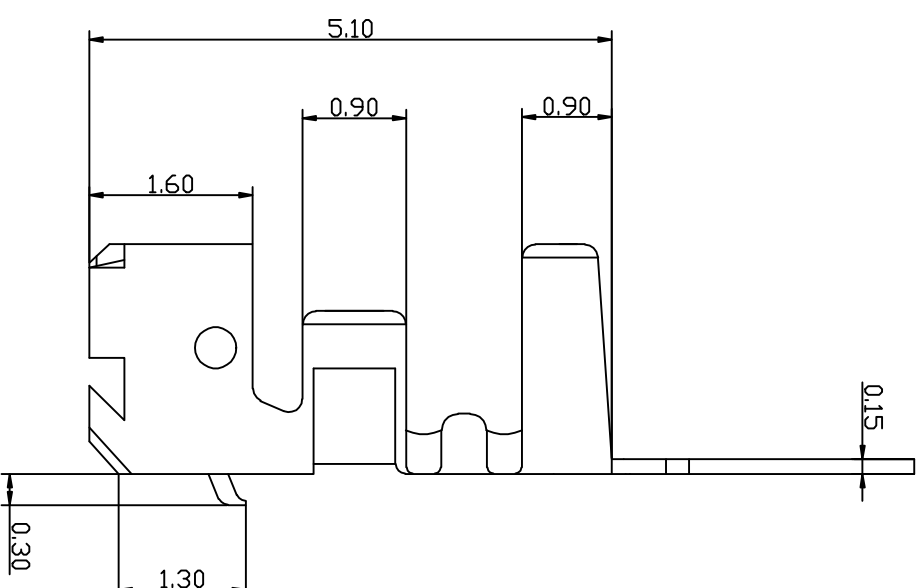
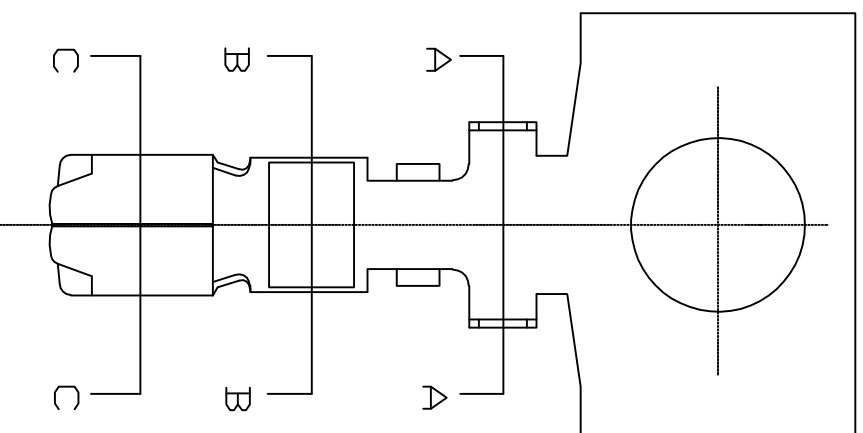

SEC: A-A

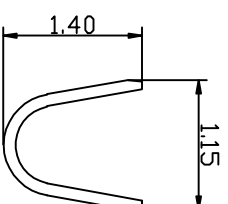

SEC: B-B

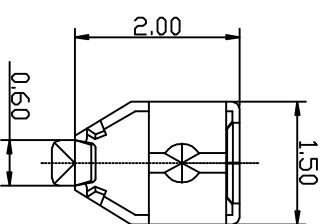

SEC: C-C

KLT 深圳市康利通电子科技有限公司

成品规格图

Tolerance

0±0.30

.0±0.25

.00±0.20

.000±0.015

1

TITLE	DATE	SCALE	VER No	SIZE
CHECKED BY	2016-05-09	1:1		
DRAWN BY	UNIT:mm		A	A4
李国常	PART No	T2002PT		

B

C

D

E

F

4

B

C

E

公差表

REV	ECN NO	LOCATIONS	DESCRIPTION	DATE	CHANGER
A			新版本	2016-05-09	李国常

4

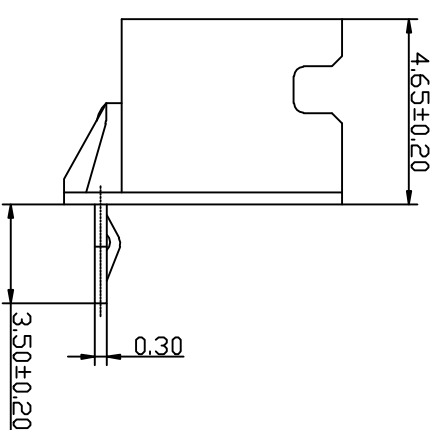
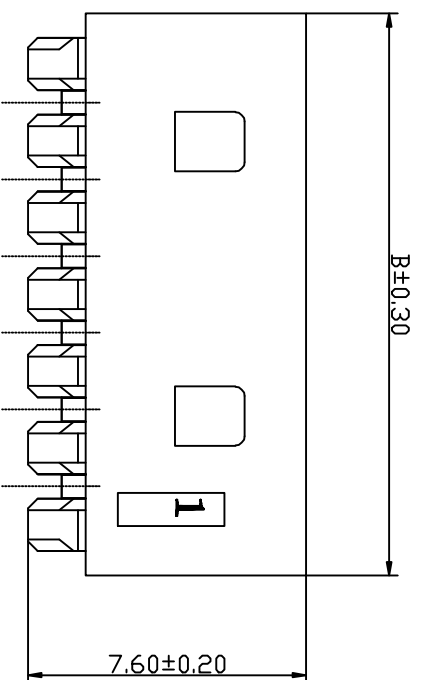
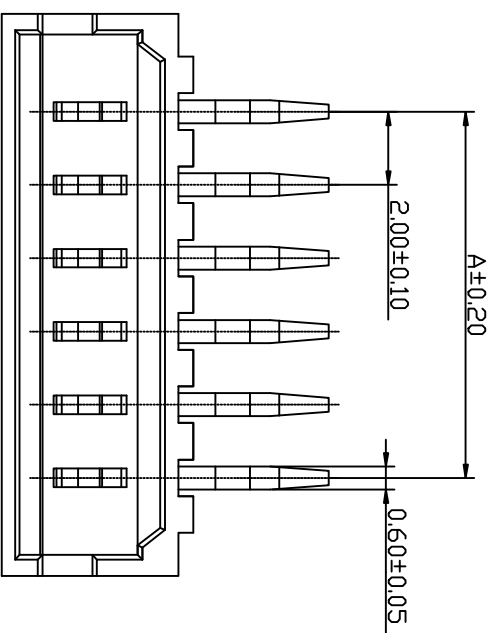

Part No	Dimensions (mm)	
	A	B
W2002R-02	2.00	6.00
W2002R-03	4.00	8.00
W2002R-04	6.00	10.00
W2002R-05	8.00	12.00
W2002R-06	10.00	14.00
W2002R-07	12.00	16.00
W2002R-08	14.00	18.00
W2002R-09	16.00	20.00
W2002R-10	18.00	22.00
W2002R-11	20.00	24.00
W2002R-12	22.00	26.00
W2002R-13	24.00	28.00
W2002R-14	26.00	30.00
W2002R-15	28.00	32.00

- SPECIFICATIONS**
- Voltage rating: 125V AC, DC
 - Current rating: 2A, AC, DC
 - Withstanding Voltage: 800V AC/minute
 - Insulation resistance: 1000MΩ min
 - Temperature range: -40℃~+85℃
 - Contact resistance: 20MΩ max
- WAFER**
- Part No: W2002R-NP
 - Poles: 02-15
 - Material: Nylon 66 UL94V-0
 - Pin Material: Brass /Tin-plated

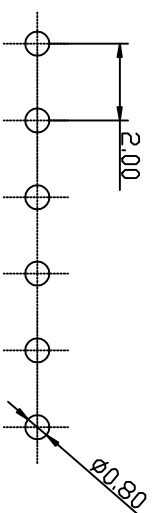

P.C.B LAYOUT

KLT 深圳市康利通电子科技有限公司

成品规格图

TOCERANCE

0±0.30

.0±0.25

.00±0.20

.000±0.015

VER No SIZE

A A4

TITLE	成品规格图		SCALE		1:1	VER No	SIZE
CHECKED BY	DATE	2016-05-09	SCALE	1:1	VER No	SIZE	
DRAWN BY	UNIT:mm						
李国常	PART No	W2002R-NP					

B

C

D

E

F

4

B

C

E

公差表

REV	ECN NO	LOCATIONS	DESCRIPTION	DATE	CHANGER
A			新版本	2016-05-09	李国常

4

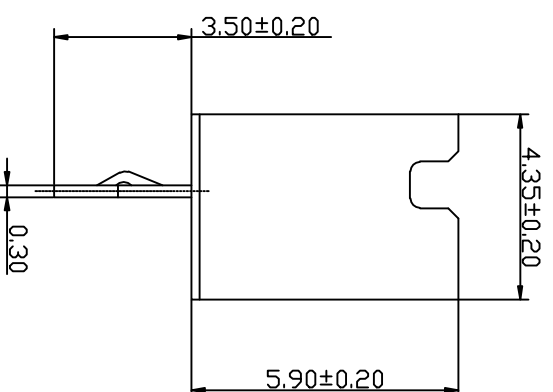
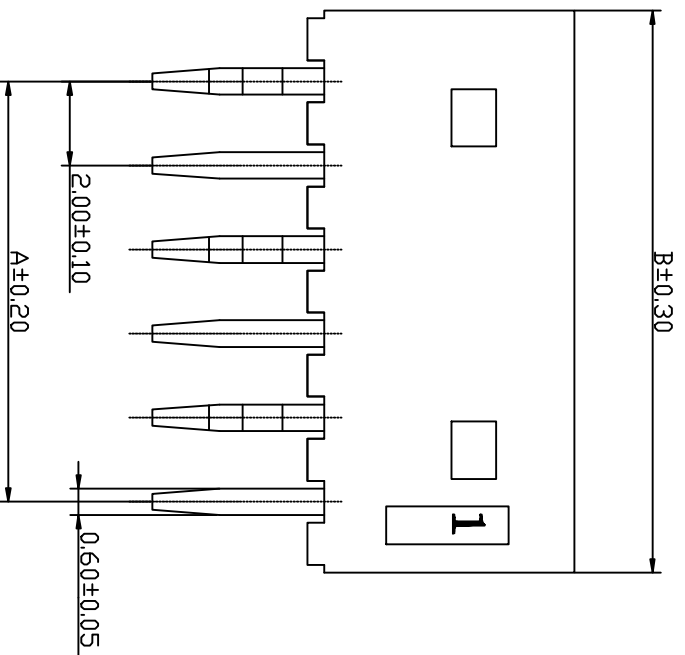
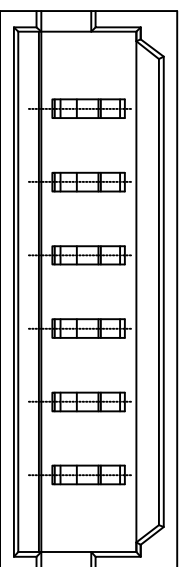

Part No	Dimensions (mm)	
	A	B
W2002V-02	2.00	6.00
W2002V-03	4.00	8.00
W2002V-04	6.00	10.00
W2002V-05	8.00	12.00
W2002V-06	10.00	14.00
W2002V-07	12.00	16.00
W2002V-08	14.00	18.00
W2002V-09	16.00	20.00
W2002V-10	18.00	22.00
W2002V-11	20.00	24.00
W2002V-12	22.00	26.00
W2002V-13	24.00	28.00
W2002V-14	26.00	30.00
W2002V-15	28.00	32.00

- SPECIFICATIONS**
- Voltage rating: 125V AC, DC
 - Current rating: 2A, AC, DC
 - Withstanding Voltage: 800V AC/minute
 - Insulation resistance: 1000MΩ min
 - Temperature range: -40°C~+85°C
 - Contact resistance: 20MΩ max
- WAFER**
- Part No: W2002V-NP
 - Poles: 02-15
 - Material: Nylon 66 UL94V-0
 - Pin Material: Brass /Tin-plated

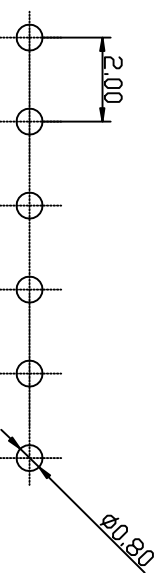

P.C.B LAYOUT

KLT 深圳市康利通电子科技有限公司

成品规格图

TOLERANCE

0±0.30

.0±0.25

.00±0.20

.000±0.015

TITLE	DATE	SCALE	VER No	SIZE
CHECKED BY	2016-05-09	1:1	A	A4

DRAWN BY	UNIT:mm	Part No
李国常	mm	W2002V-NP

PART No	WAFER
李国常	W2002V-NP

B

C

D

E

F

1

4