

B

C

E

公差表

REV	ECN NO	LOCATIONS	DESCRIPTION	DATE	CHANGER
A			新版本	2016-05-13	李国常

SPECIFICATIONS

- Voltage rating: 300V AC, DC
- Current rating: 3A, AC, DC
- Withstanding Voltage: 1000V AC/minute
- Insulation resistance: 100MΩ min
- Temperature range: -40℃~+85℃
- Contact resistance: 20MΩ max

HOUSING

- Part No: H2009-NP
- Poles: 02-15
- Material: Nylon 66 UL94V-0

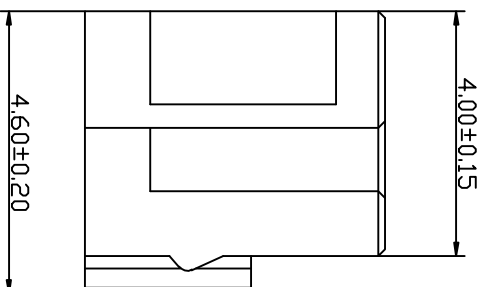
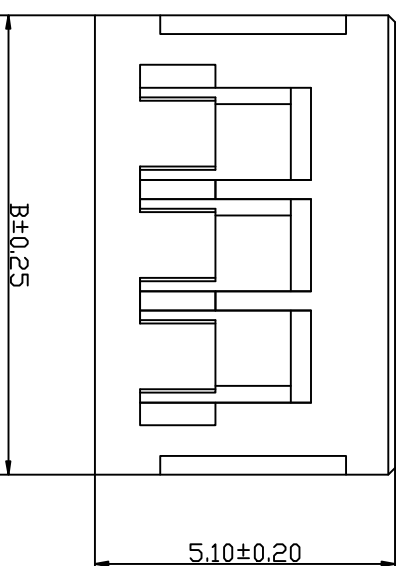

Part No	Dimensions (mm)	
	A	B
H2009-02	2.00	6.00
H2009-03	4.00	8.00
H2009-04	6.00	10.00
H2009-05	8.00	12.00
H2009-06	10.00	14.00
H2009-07	12.00	16.00
H2009-08	14.00	18.00
H2009-09	16.00	20.00
H2009-10	18.00	22.00
H2009-11	20.00	24.00
H2009-12	22.00	26.00
H2009-13	24.00	28.00
H2009-14	26.00	30.00
H2009-15	28.00	32.00

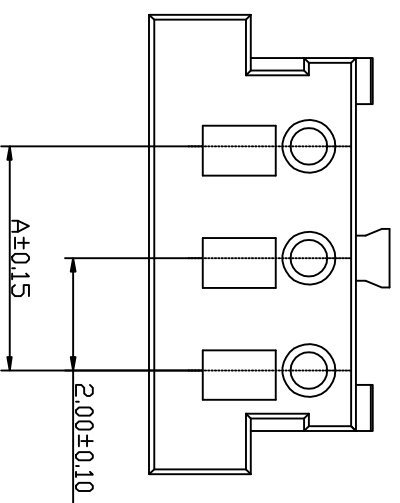

KLIT 深圳市康利通电子科技有限公司

TITLE

成品规格图

TOLERANCE

0±0.30

.0±0.25

.00±0.20

CHECKED BY

DATE

SCALE

.000±0.015

DRAWN BY

2016-05-13

1:1

VER No SIZE

李国常

UNIT:mm



A A4

李国常

PART NO

H2009-NP

4

4

B

C

D

E

F

1

B

C

E

公差表

REV	ECN NO	LOCATIONS	DESCRIPTION	DATE	CHANGER
A			新版本	2016-05-13	李国常

SPECIFICATIONS

- Voltage rating: 125V AC, DC
- Current rating: 4A, AC, DC
- Withstanding Voltage: 1000V AC/minute
- Insulation resistance: 1000MΩ min
- Temperature range: -40℃~+85℃
- Contact resistance: 10MΩ max

TERMINAL

- Part No: T2009PT
- Applicable wire: AWG#22-#26
- Material: Phosphor Bronze
- Finish: Tin plated

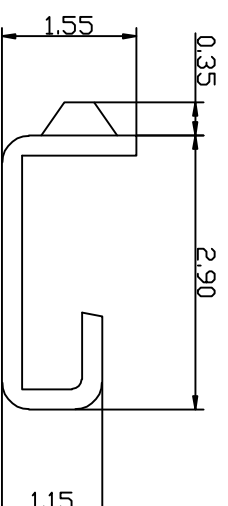
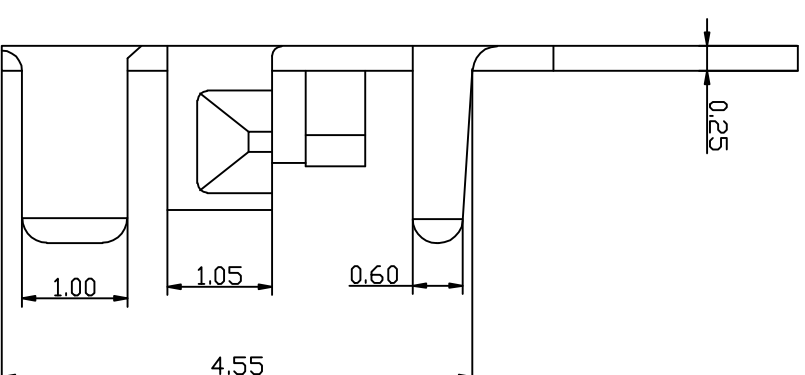
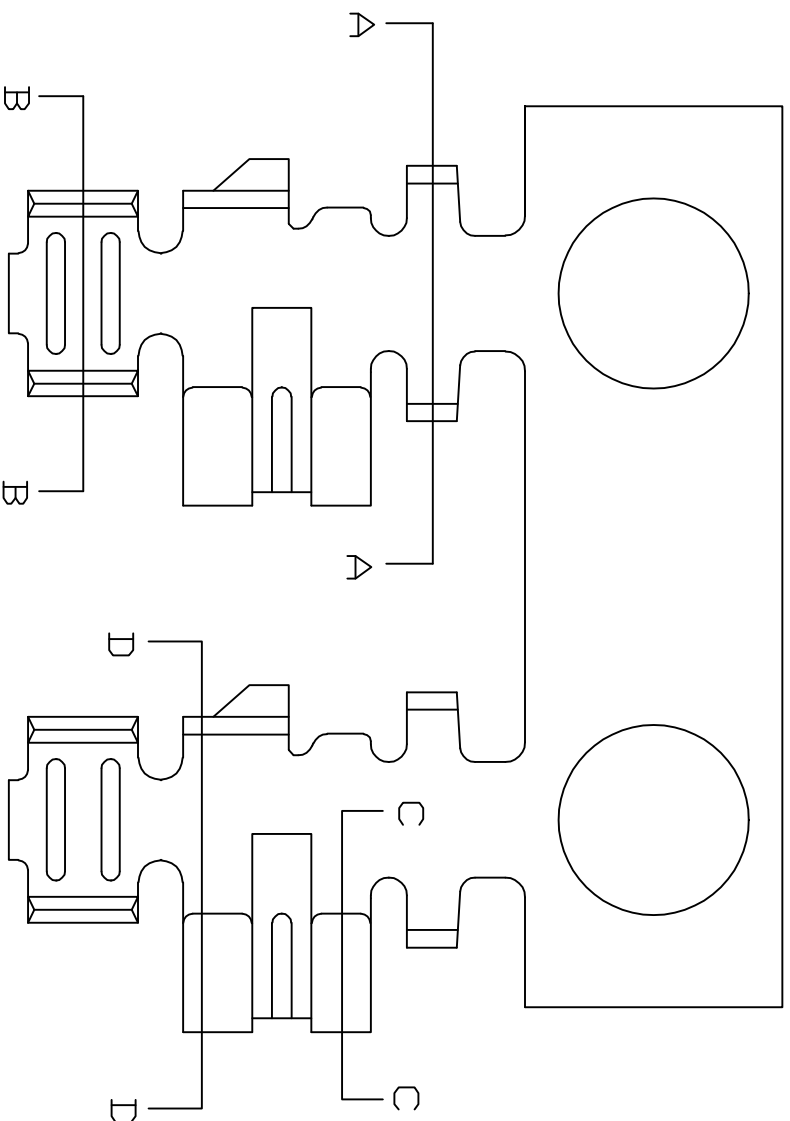

SEC: D-D

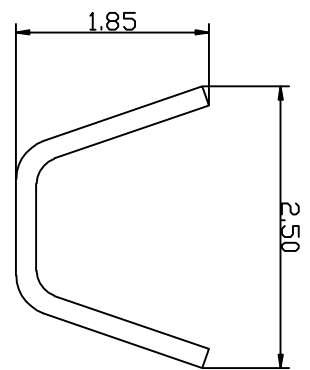

SEC: A-A

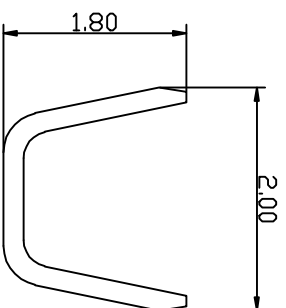

SEC: B-B

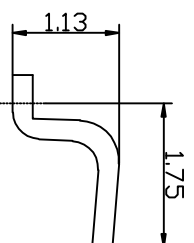

SEC: C-C

KLT 深圳市康利通电子科技有限公司

成品规格图

Tolerance

0±0.30

.0±0.25

.00±0.20

.000±0.015

1

TITLE	DATE	SCALE	VER No	SIZE
CHECKED BY	2016-05-13	1:1		
DRAWN BY	UNIT:mm		A	A4
李国常	PART No	T2009PT		

B

C

D

E

F

4

4

B

C

E

公差表

REV	ECN NO	LOCATIONS	DESCRIPTION	DATE	CHANGER
A			新版本	2016-05-13	李国常

4

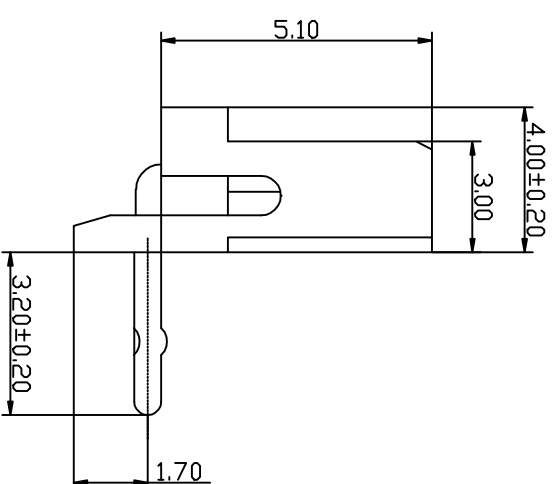
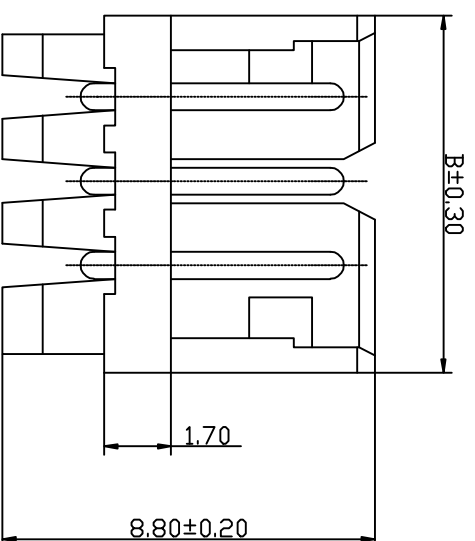
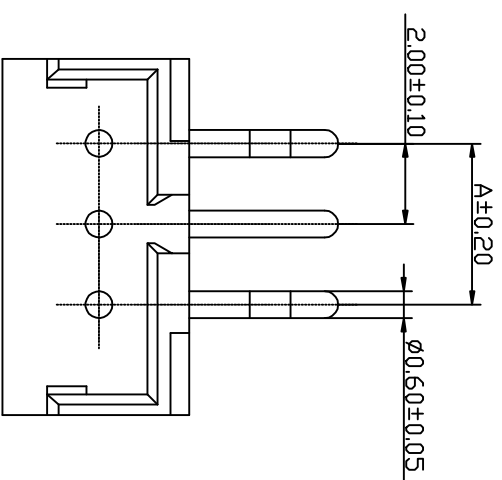

Part No	Dimensions (mm)	
	A	B
W2009R-02	2.00	6.00
W2009R-03	4.00	8.00
W2009R-04	6.00	10.00
W2009R-05	8.00	12.00
W2009R-06	10.00	14.00
W2009R-07	12.00	16.00
W2009R-08	14.00	18.00
W2009R-09	16.00	20.00
W2009R-10	18.00	22.00
W2009R-11	20.00	24.00
W2009R-12	22.00	26.00
W2009R-13	24.00	28.00
W2009R-14	26.00	30.00
W2009R-15	28.00	32.00

- SPECIFICATIONS**
- Voltage rating: 125V AC, DC
 - Current rating: 4A, AC, DC
 - Withstanding Voltage: 1000V AC/minute
 - Insulation resistance: 1000MΩ min
 - Temperature range: -40°C~+85°C
 - Contact resistance: 10MΩ max
- WAFER**
- Part No: W2009R-NP
 - Poles: 02-15
 - Material: Nylon 66 UL94V-0
 - Pin Material: Brass /Tin-plated

4

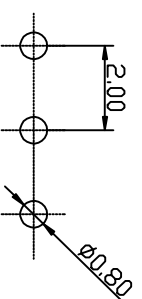

P.C.B LAYOUT

KLT 深圳市康利通电子科技有限公司

成品规格图

TOLERANCE

0±0.30

.0±0.25

.00±0.20

.000±0.015

1

TITLE	成品规格图		TOLERANCE	
CHECKED BY	DATE	SCALE	VER No	SIZE
	2016-05-13	1:1	A	A4

DRAWN BY	UNIT:mm	PART No		
李国常		W2009R-NP		

B

C

D

E

F

B

C

E

公差表

REV	ECN NO	LOCATIONS	DESCRIPTION	DATE	CHANGER
A			新版本	2016-05-13	李国常

4

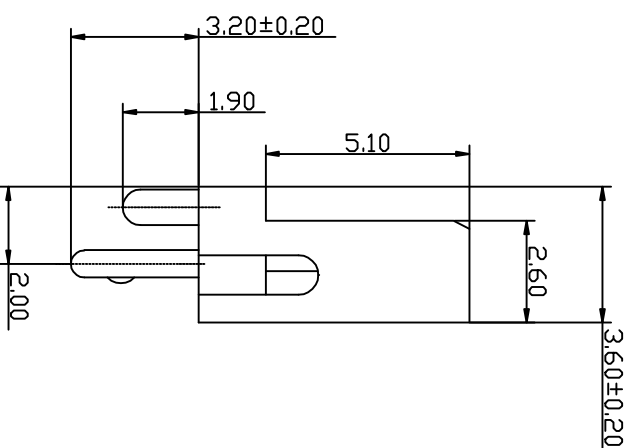
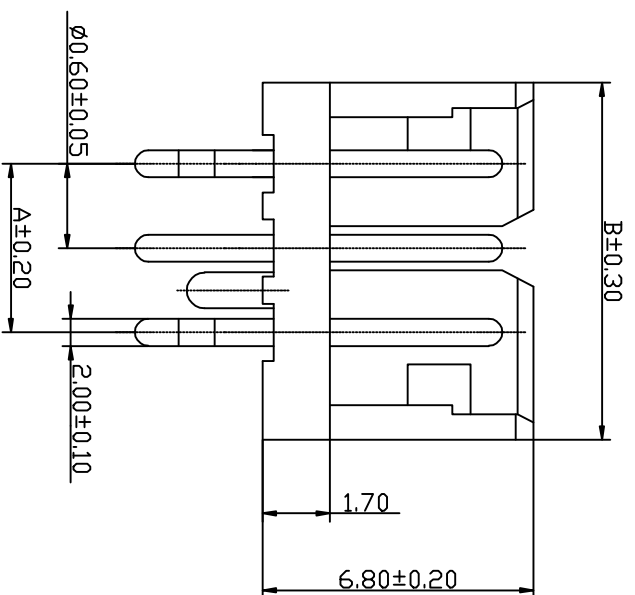
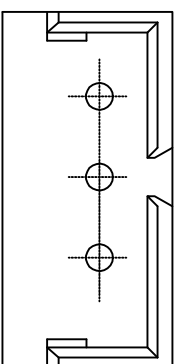

- SPECIFICATIONS**
- Voltage rating: 125V AC, DC
 - Current rating: 4A, AC, DC
 - Withstanding Voltage: 1000V AC/minute
 - Insulation resistance: 1000MΩ min
 - Temperature range: -40℃~+85℃
 - Contact resistance: 10MΩ max
- WAFER**
- Part No: W2009VD-NP
 - Poles: 02-15
 - Material: Nylon 66 UL94V-0
 - Pin Material: Brass /Tin-plated

Part No	Dimensions (mm)	
	A	B
W2009VD-02	2.00	6.00
W2009VD-03	4.00	8.00
W2009VD-04	6.00	10.00
W2009VD-05	8.00	12.00
W2009VD-06	10.00	14.00
W2009VD-07	12.00	16.00
W2009VD-08	14.00	18.00
W2009VD-09	16.00	20.00
W2009VD-10	18.00	22.00
W2009VD-11	20.00	24.00
W2009VD-12	22.00	26.00
W2009VD-13	24.00	28.00
W2009VD-14	26.00	30.00
W2009VD-15	28.00	32.00

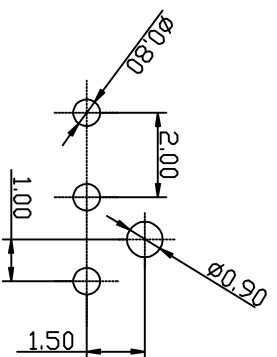

P.C.B LAYOUT

KLT 深圳市康利通电子科技有限公司

成品规格图

TOLERANCE

0±0.30

.0±0.25

.00±0.20

.000±0.015

TITLE	成品规格图		TOLERANCE	
CHECKED BY	DATE	SCALE	VER No	SIZE
	2016-05-13	1:1	A	A4

DRAWN BY	UNIT:mm	PART No		W2009VD-NP
李国常				

B

C

D

E

F

1

4

B

C

E

公差表

REV	ECN NO	LOCATIONS	DESCRIPTION	DATE	CHANGER
A			新版本	2016-05-13	李国常

4

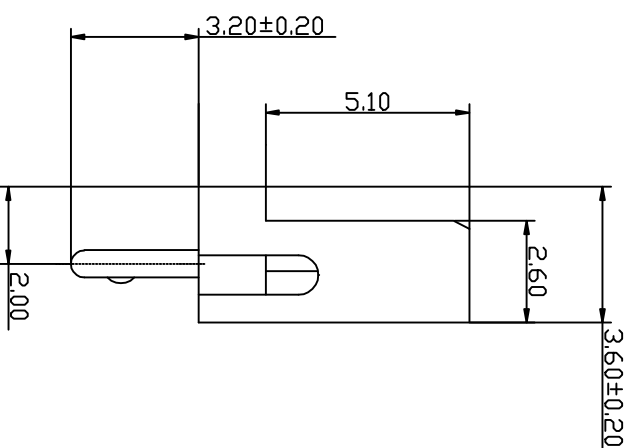
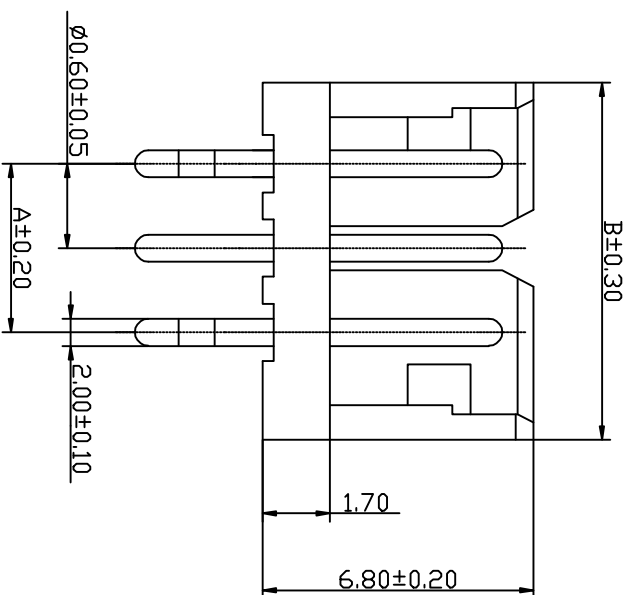
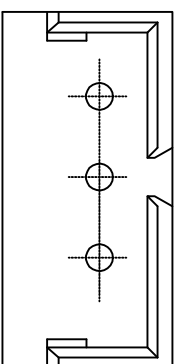

- SPECIFICATIONS**
- Voltage rating: 125V AC, DC
 - Current rating: 4A, AC, DC
 - Withstanding Voltage: 1000V AC/minute
 - Insulation resistance: 1000MΩ min
 - Temperature range: -40°C~+85°C
 - Contact resistance: 10MΩ max
- WAFER**
- Part No: W2009V-NP
 - Poles: 02-15
 - Material: Nylon 66 UL94V-0
 - Pin Material: Brass /Tin-plated

Part No	Dimensions (mm)	
	A	B
W2009V-02	2.00	6.00
W2009V-03	4.00	8.00
W2009V-04	6.00	10.00
W2009V-05	8.00	12.00
W2009V-06	10.00	14.00
W2009V-07	12.00	16.00
W2009V-08	14.00	18.00
W2009V-09	16.00	20.00
W2009V-10	18.00	22.00
W2009V-11	20.00	24.00
W2009V-12	22.00	26.00
W2009V-13	24.00	28.00
W2009V-14	26.00	30.00
W2009V-15	28.00	32.00

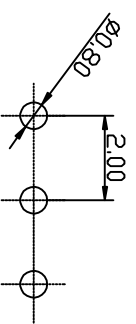

P.C.B LAYOUT

KLT 深圳市康利通电子科技有限公司

成品规格图

TOLERANCE

0±0.30

.0±0.25

.00±0.20

.000±0.015

VER No SIZE

A A4

TITLE	成品规格图		TOLERANCE	
CHECKED BY	DATE	SCALE	VER No	SIZE
DRAWN BY	UNIT:mm		A	A4
李国常	2016-05-13	1:1		
PART No	W2009V-NP			

B

C

D

E

F

1

4