

B

C

E

公差表

REV	ECN NO	LOCATIONS	DESCRIPTION	DATE	CHANGER
A			新版本	2016-04-20	李国常

■ SPECIFICATIONS

- Voltage rating: 125V AC, DC
- Current rating: 1A, AC, DC
- Withstanding Voltage: 500V AC/minute
- Insulation resistance: 100MΩ min
- Temperature range: -40℃~+85℃
- Contact resistance: 20MΩ max

■ HOUSING

- Part No: H1256-NP
- Poles: 02-15
- Material: Nylon 66 UL94V-0

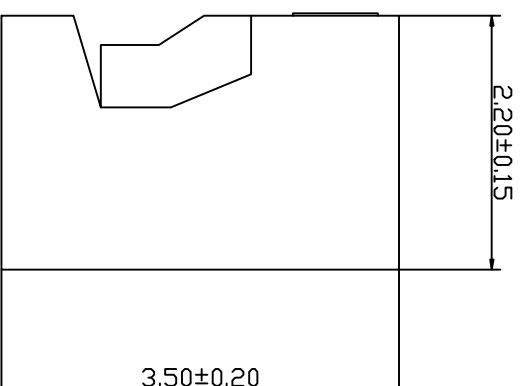
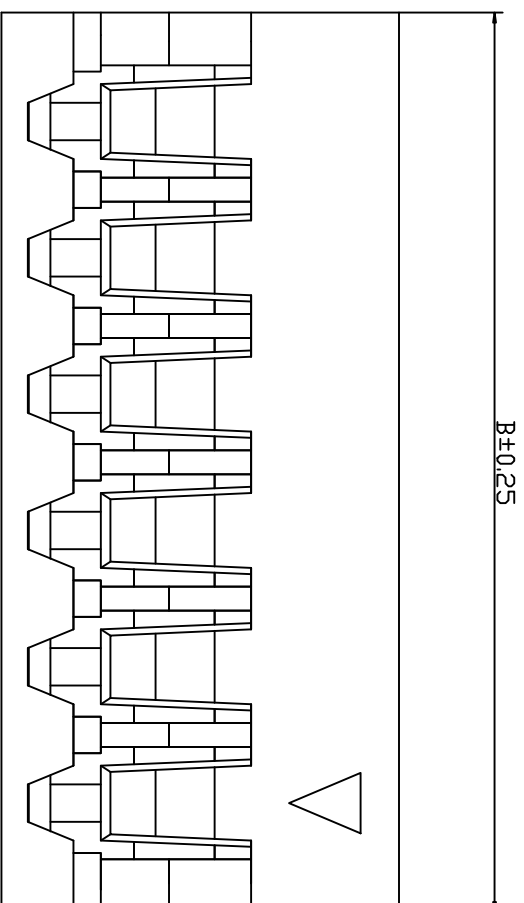

Part No	Dimensions (mm)	
	A	B
H1256-02	1.25	3.05
H1256-03	2.50	4.30
H1256-04	3.75	5.55
H1256-05	5.00	6.80
H1256-06	6.25	8.05
H1256-07	7.50	9.30
H1256-08	8.75	10.55
H1256-09	10.00	11.80
H1256-10	11.25	13.05
H1256-11	12.50	14.30
H1256-12	13.75	14.55
H1256-13	15.00	16.80
H1256-14	16.25	18.05
H1256-15	17.50	19.30

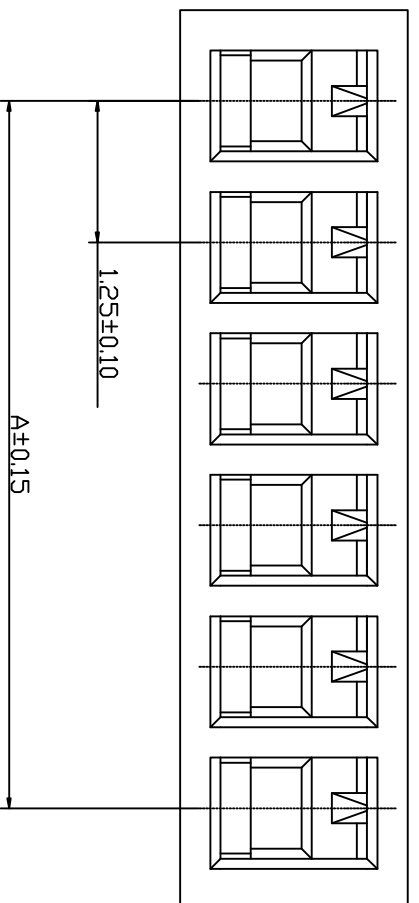

KLT 深圳市康利通电子科技有限公司

TOLERANCE

0±0.30

.0±0.25

.00±0.20

.000±0.015

VER No SIZE

A A4

TITLE

成品规格图

CHECKED BY

DATE

SCALE

2016-04-20

1:1

DRAWN BY

UNIT:mm



李国常

PART NO

H1256-NP

4

4

B

C

D

E

F

1

B

C

E

公差表

REV	ECN NO	LOCATIONS	DESCRIPTION	DATE	CHANGER
A			新版本	2016-04-20	李国常

SPECIFICATIONS

- Voltage rating: 125V AC,DC
- Current rating: 1A, AC, DC
- Withstanding Voltage: 500V AC/minute
- Insulation resistance: 100MΩ min
- Temperature range: -40℃~+85℃
- Contact resistance: 20MΩ max

TERMINAL

- Part No: T1256PT
- Applicable wire: AWG#28-#32
- Material: Phosphor Bronze
- Finish: Tin Plated

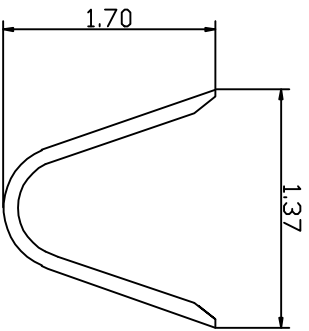
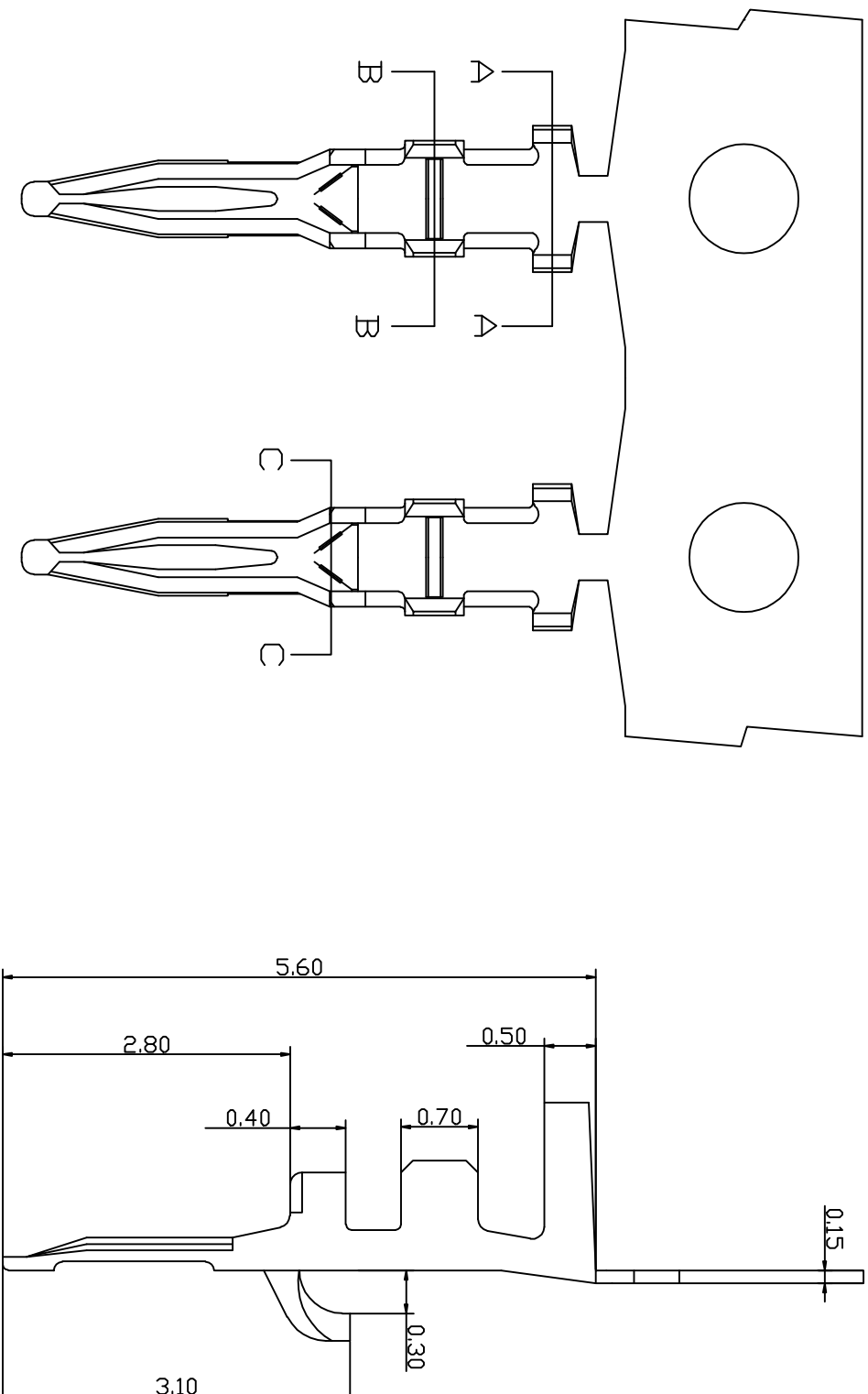

SEC: A-A

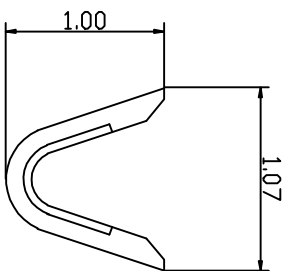

SEC: B-B

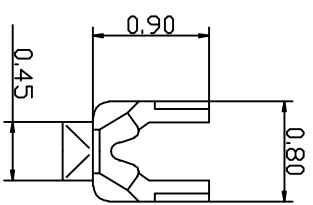

SEC: C-C

KLT 深圳市康利通电子科技有限公司

TITLE

成品规格图

TOLERANCE

0±0.30

.0±0.25

.00±0.20

.000±0.015

CHECKED BY	DATE	SCALE	VER No	SIZE
	2016-04-20	1:1		

DRAWN BY

UNIT:mm

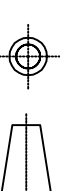

A

A4

李国常

PART No

T1256PT

B

C

D

E

F

1

4