

B

C

E

公差表

REV	ECN NO	LOCATIONS	DESCRIPTION	DATE	CHANGER
A			新版本	2016-04-27	李国常

**SPECIFICATIONS**

- Voltage rating: 200V AC, DC
- Current rating: 1A, AC, DC
- Withstanding Voltage: 500V AC/minute
- Insulation resistance: 100MΩ min
- Temperature range: -40℃~+85℃
- Contact resistance: 20MΩ max

**HOUSING**

- Part No: H1255-NP
- Poles: 02-30
- Material: Nylon 66 UL94V-0

4

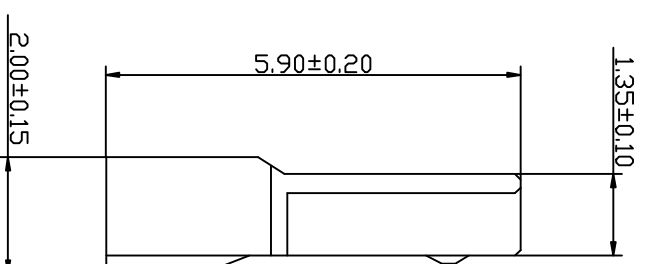
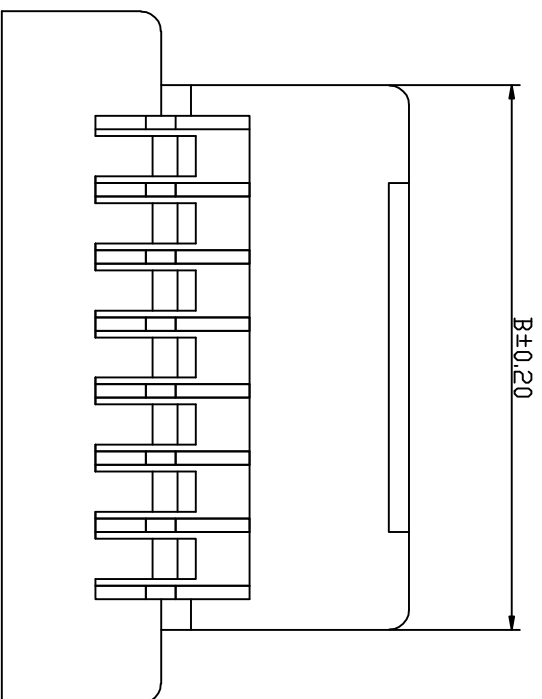

Part No	Dimensions (mm)		
	A	B	C
H1255-02	1.25	3.80	6.00
H1255-03	2.50	5.05	7.25
H1255-04	3.75	6.30	8.50
H1255-05	5.00	7.55	9.75
H1255-06	6.25	8.80	11.00
H1255-08	8.75	11.30	13.50
H1255-10	11.25	13.80	16.00
H1255-15	17.50	20.05	22.25
H1255-20	23.75	26.30	28.50
H1255-25	30.00	32.55	34.75
H1255-30	36.25	38.80	41.00

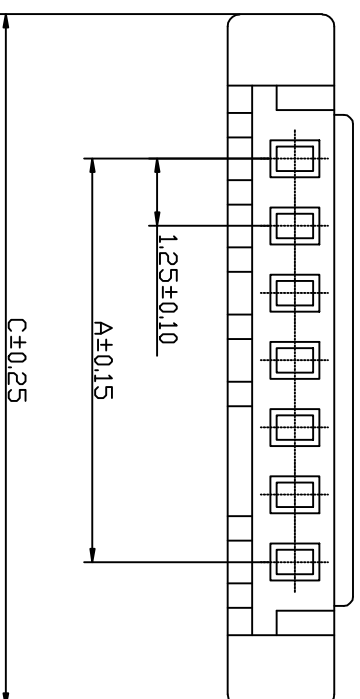

**KLT** 深圳市康利通电子科技有限公司

TOLERANCE

0±0.30

.0±0.25

.00±0.20

.000±0.015

1

成品规格图

TITLE	成品规格图		TOLERANCE	
CHECKED BY	DATE	SCALE	VER No	SIZE
DRAWN BY	UNIT:mm	1:1	A	A4
DRAWN BY	UNIT:mm	1:1	A	A4
CHECKED BY	DATE	SCALE	VER No	SIZE
2016-04-27	1:1			
PART No	H1255-NP			
李国常				

B

C

D

E

F

4

B

C

E

公差表

REV	ECN NO	LOCATIONS	DESCRIPTION	DATE	CHANGER
A			新版本	2016-04-27	李国常

**SPECIFICATIONS**

- Voltage rating: 200V AC,DC
- Current rating: 1A, AC, DC
- Withstanding Voltage: 500V AC/minute
- Insulation resistance: 100MΩ min
- Temperature range: -40℃~+85℃
- Contact resistance: 20MΩ max

**HOUSING**

- Part No: H1255R-NP
- Poles: 05-41
- Material: Nylon 66 UL94V-0

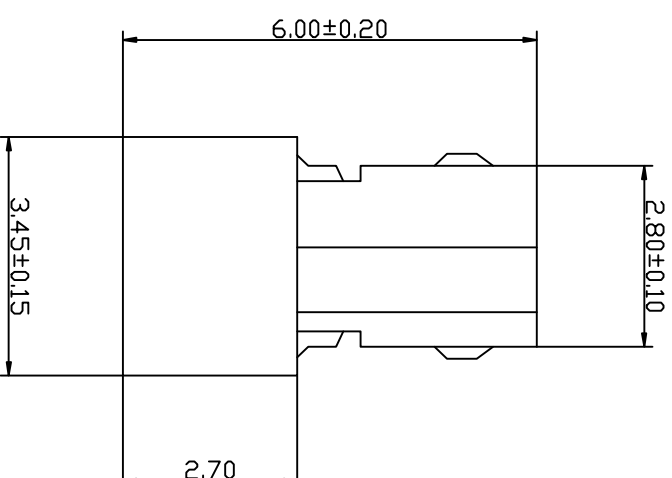
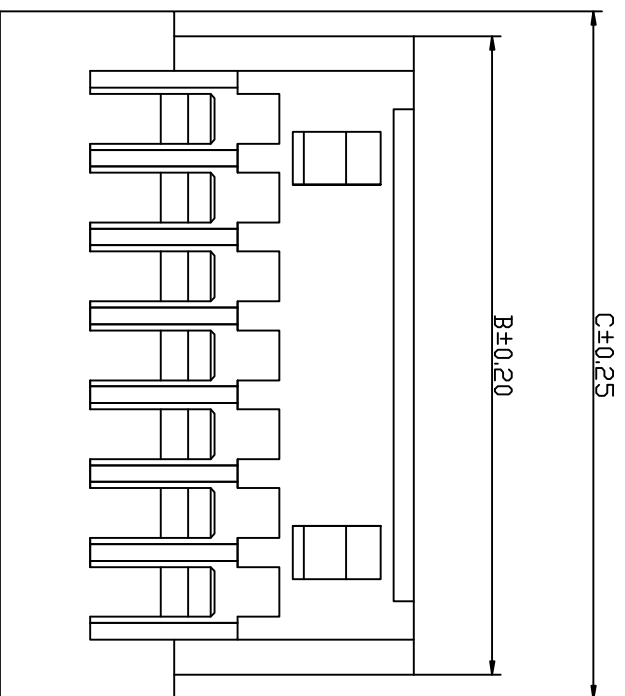

Part No	Dimensions (mm)		
	A	B	C
H1255R-05	2.50	4.90	6.00
H1255R-07	3.75	6.15	7.25
H1255R-09	5.00	7.40	8.50
H1255R-11	6.25	8.65	9.75
H1255R-13	7.50	9.90	11.00
H1255R-15	8.75	11.15	12.25
H1255R-17	10.00	12.40	13.50
H1255R-19	11.25	13.65	14.75
H1255R-21	12.50	14.90	16.00
H1255R-31	18.75	21.15	22.25
H1255R-41	25.00	27.40	28.50

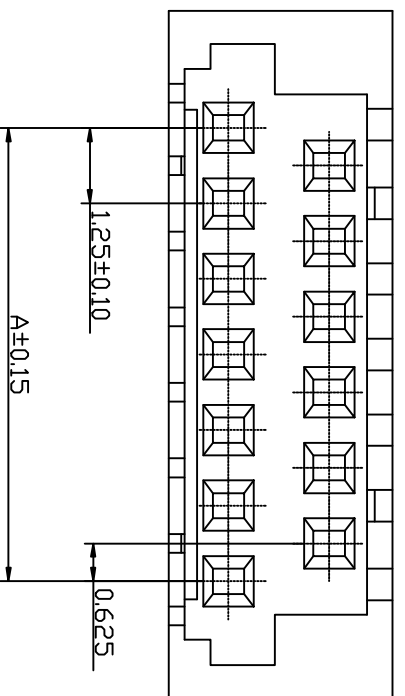

**KLT** 深圳市康利通电子科技有限公司

成品规格图

TOCERANCE

0±0.30

.0±0.25

.00±0.20

.000±0.015

VER No SIZE

A A4

TITLE

CHECKED BY

DATE 2016-04-27

DRAWN BY

李国常

DATE

UNIT:mm

PART No

H1255R-NP

SCALE

1:1

VER No

A

SIZE

A4

H1255R-NP

A4

4

4

B

C

D

E

F

1

B

C

E

公差表

REV	ECN NO	LOCATIONS	DESCRIPTION	DATE	CHANGER
A			新版本	2016-04-27	李国常

4

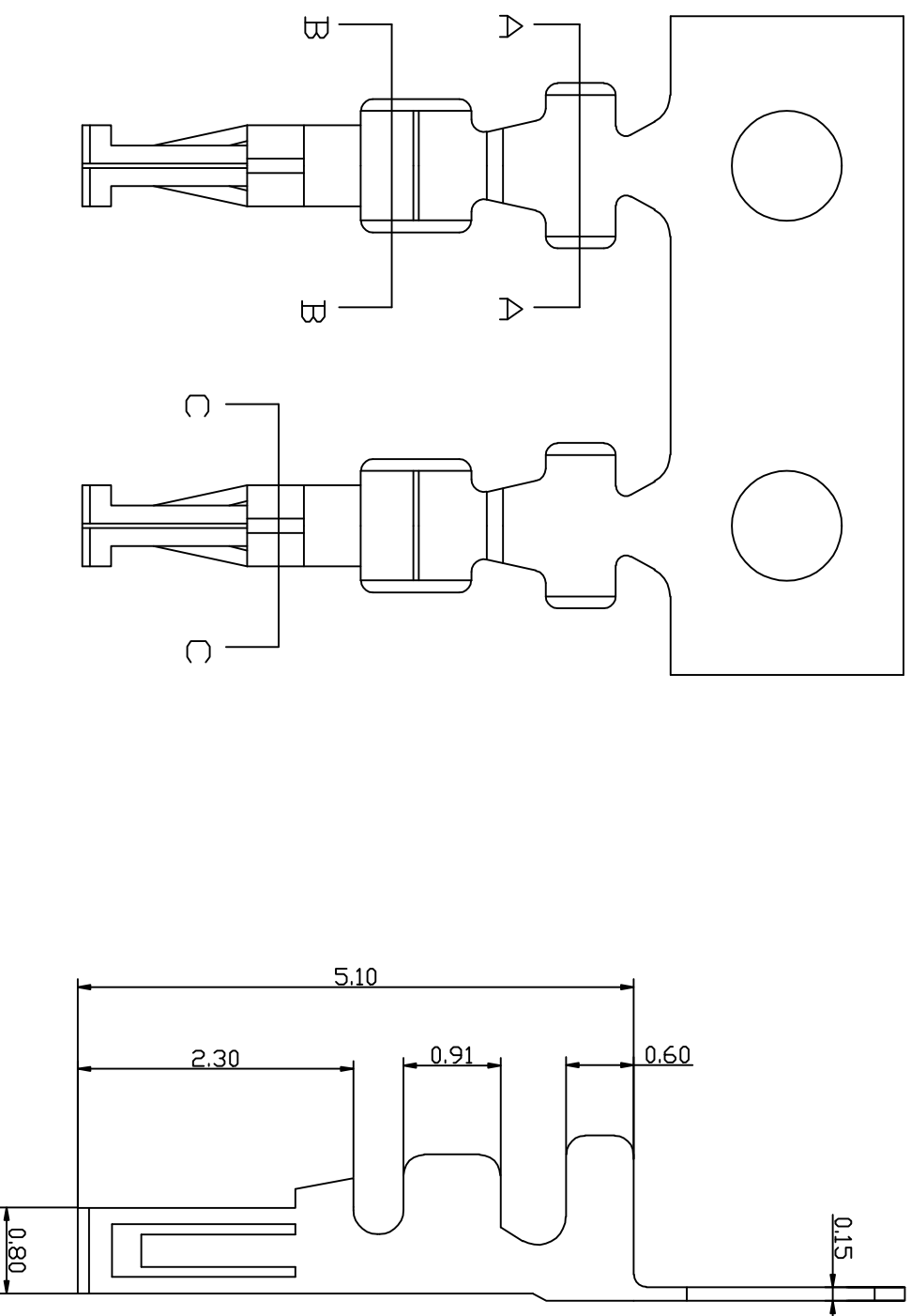

- SPECIFICATIONS**
- Voltage rating: 200V AC, DC
  - Current rating: 1A, AC, DC
  - Withstanding Voltage: 500V AC/minute
  - Insulation resistance: 100MΩ min
  - Temperature range: -40℃~+85℃
  - Contact resistance: 20MΩ max
- TERMINAL**
- Part No: T1255PG
  - Applicable wire: AWG#28-#32
  - Material: Phosphor Bronze
  - Finish: Gold-flash

4

SEC:A-A

SEC:B-B

SEC:C-C

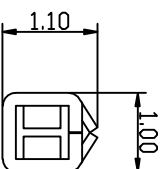
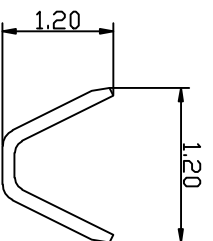
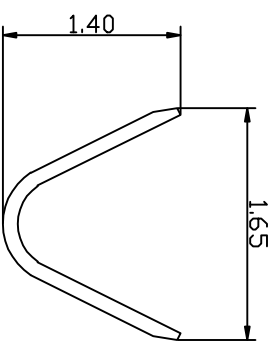

**KLT** 深圳市康利通电子科技有限公司

成品规格图

Tolerance

0±0.30

.0±0.25

.00±0.20

.000±0.015

1

TITLE	DATE	SCALE	VER No	SIZE
CHECKED BY	2016-04-27	1:1		
DRAWN BY	UNIT:mm		A	A4
李国常	PART No	T1255PG		

B

C

D

E

F

B

C

E

公差表

REV	ECN NO	LOCATIONS	DESCRIPTION	DATE	CHANGER
A			新版本	2016-04-27	李国常

4

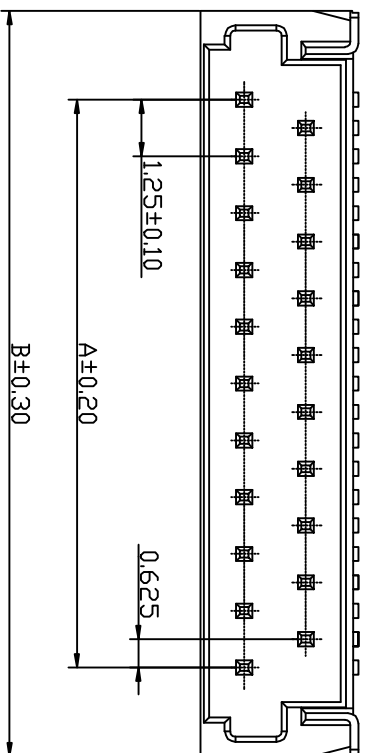

4

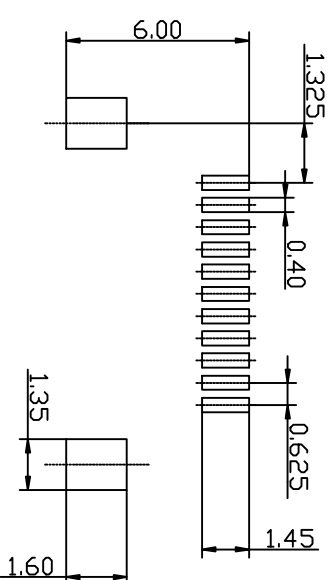
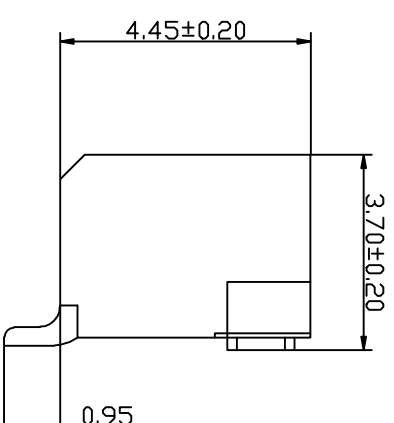
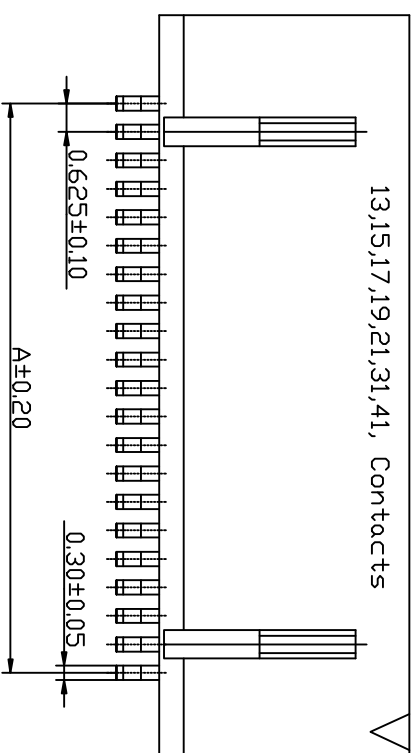

P.C.B LAYOUT

Part No	Dimensions (mm)	
	A	B
W1255R-05	2.50	6.10
W1255R-07	3.75	7.35
W1255R-09	5.00	8.60
W1255R-11	6.25	9.85
W1255R-13	7.50	11.10
W1255R-15	8.75	12.35
W1255R-17	10.00	13.60
W1255R-19	11.25	14.85
W1255R-21	12.50	16.10
W1255R-31	18.75	22.35
W1255R-41	25.00	28.60

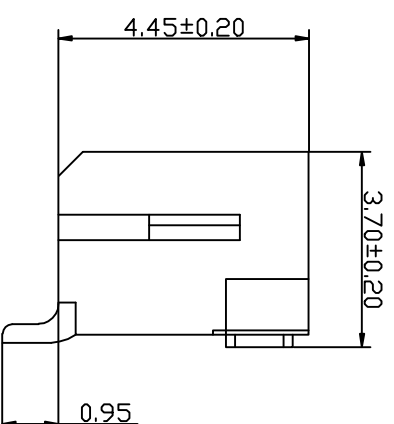
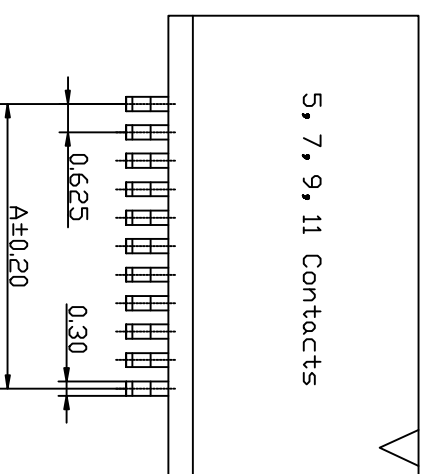

**KLT** 深圳市康利通电子科技有限公司

成品规格图

TOCERANCE

0±0.30

.0±0.25

.00±0.20

.000±0.015

VER No SIZE

A A4

1

TITLE	DATE	SCALE	VER No	SIZE
CHECKED BY	2016-04-27	1:1	A	A4
DRAWN BY	UNIT:mm			
李国常	PART NO	W1255R-NP		

B

C

D

E

F

B

C

E

公差表

REV	ECN NO	LOCATIONS	DESCRIPTION	DATE	CHANGER
A			新版本	2016-04-27	李国常

4

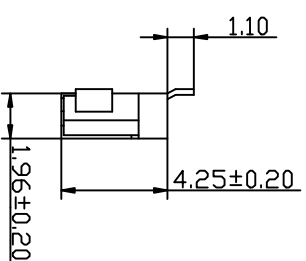
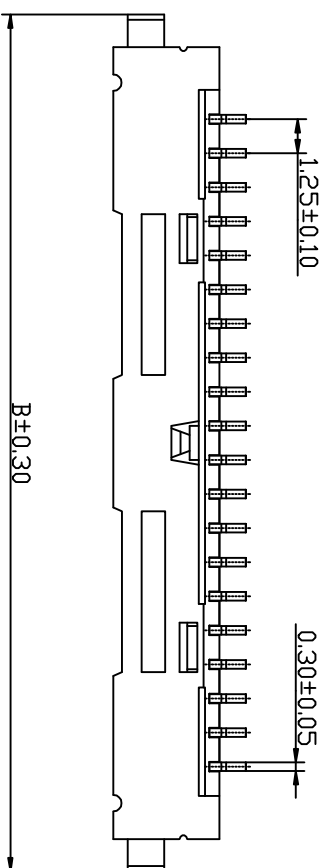
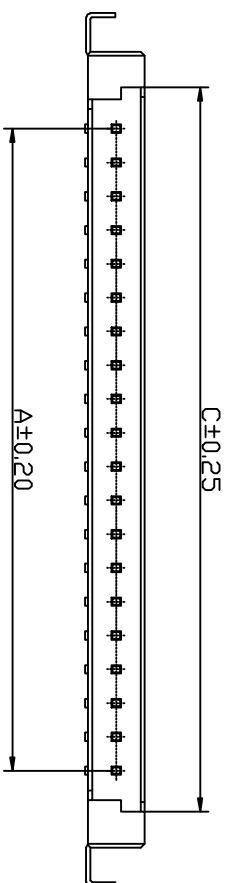

4

- SPECIFICATIONS**
- Voltage rating: 200V AC, DC
  - Current rating: 1A, AC, DC
  - Withstanding Voltage: 500V AC/minute
  - Insulation resistance: 100MΩ min
  - Temperature range: -40°C~+85°C
  - Contact resistance: 20MΩ max

- WAFER**
- Part No: W1255SR-NP
  - Poles: 20, 30
  - Material: LCP UL94V-0
  - Ter Material: Brass /Tin-plated

Part NO	Dimensions (mm)		
	A	B	C
H1255SR-20	23.75	31.40	26.60
H1255SR-30	36.25	43.90	39.10

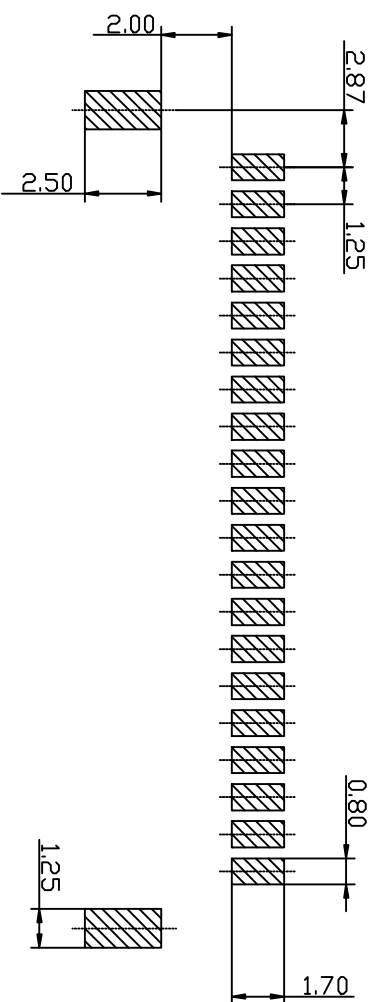

P.C.B LAYOUT

**KLIT** 深圳市康利通电子科技有限公司

TO CERANCE

0±0.30

.0±0.25

.00±0.20

.000±0.015

1

TITLE	成品规格图		SCALE		VER No	SIZE
CHECKED BY	DATE	SCALE	1:1	VER No	SIZE	
DRAWN BY	UNIT:mm	A		A4		
PART NO	W1255SR-NP					
李国常						

B

C

D

E

F

B

C

E

公差表

REV	ECN NO	LOCATIONS	DESCRIPTION	DATE	CHANGER
A			新版本	2016-04-27	李国常

4

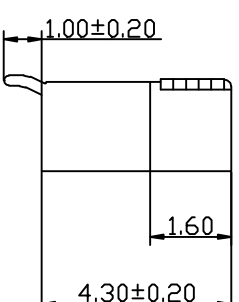
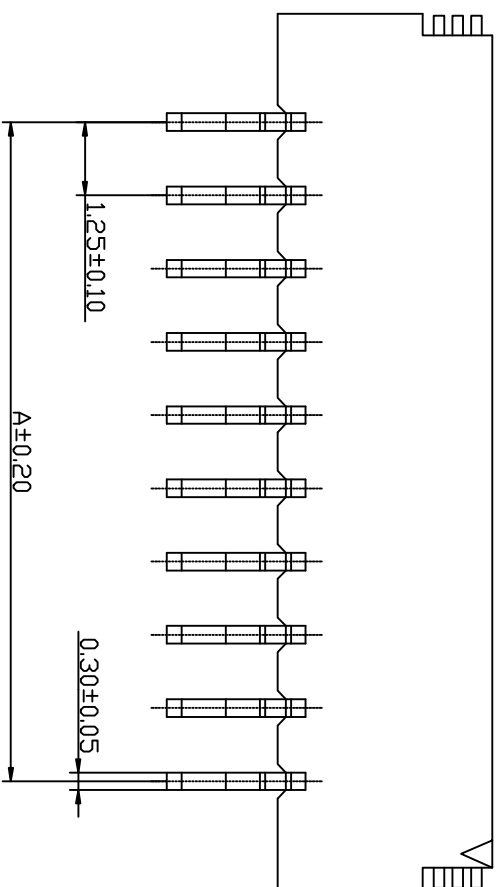
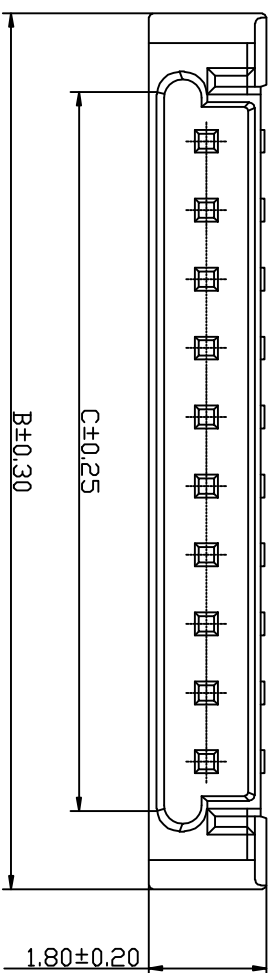

Part NO	Dimensions (mm)		
	A	B	C
W1255SR-02-1	1.25	6.10	4.01
W1255SR-03-1	2.50	7.35	5.26
W1255SR-04-1	3.75	8.60	6.51
W1255SR-05-1	5.00	9.85	7.76
W1255SR-06-1	6.25	11.05	9.01
W1255SR-08-1	8.75	13.60	11.51
W1255SR-10-1	11.25	16.05	14.01
W1255SR-15-1	17.50	22.35	20.26
W1255SR-20-1	23.75	28.60	26.51
W1255SR-25-1	30.00	34.85	32.76
W1255SR-30-1	36.25	41.10	39.01

- SPECIFICATIONS**
- Voltage ratings: 200V AC, DC
  - Current ratings: 1A, AC, DC
  - Withstanding Voltage: 500V AC/minute
  - Insulation resistance: 100MΩ min
  - Temperature range: -40℃~+85℃
  - Contact resistance: 20MΩ max
- WAFER
- Part No: W1255SR-NP-1
  - Poles: 02-30
  - Material: Nylon 6T UL94V-0
  - Ter Material: Brass /Tin-plated

4

B

C

D

E

F

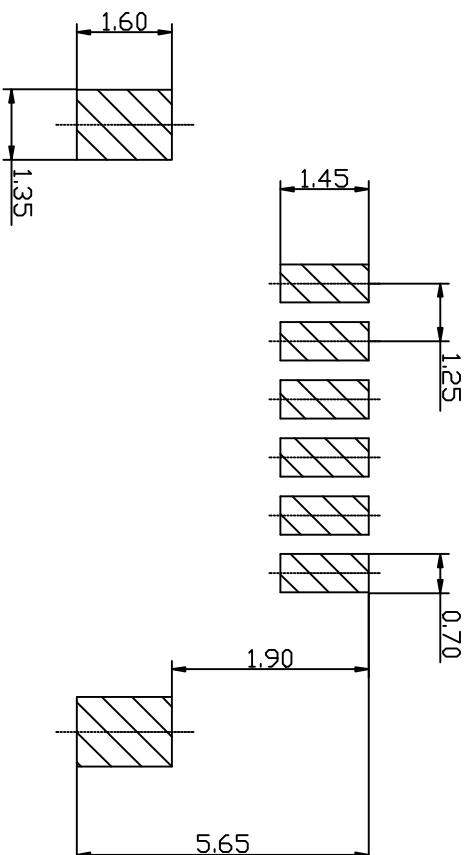

P.C.B LAYOUT

**KLT** 深圳市康利通电子科技有限公司

成品规格图

TOLERANCE

0±0.30

.0±0.25

.00±0.20

.000±0.015

VER No SIZE

A A4

1

TITLE	成品规格图		TOLERANCE	
CHECKED BY	DATE	SCALE	VER No	SIZE
DRAWN BY	UNIT:mm	1:1	A	A4
李国常	2016-04-27			
PART NO	W1255SR-NP-1			