

B

C

E

公差表

REV	ECN NO	LOCATIONS	DESCRIPTION	DATE	CHANGER
A			新版本	2016-04-08	李国常

4

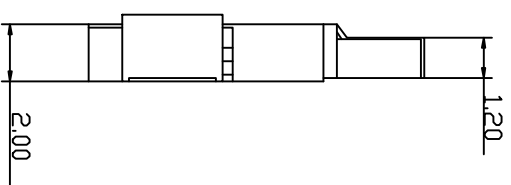
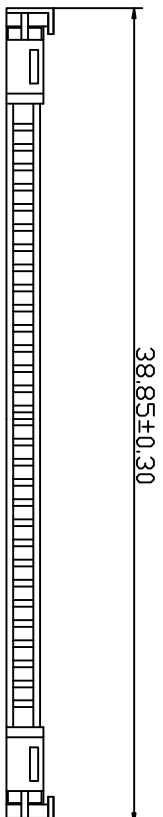
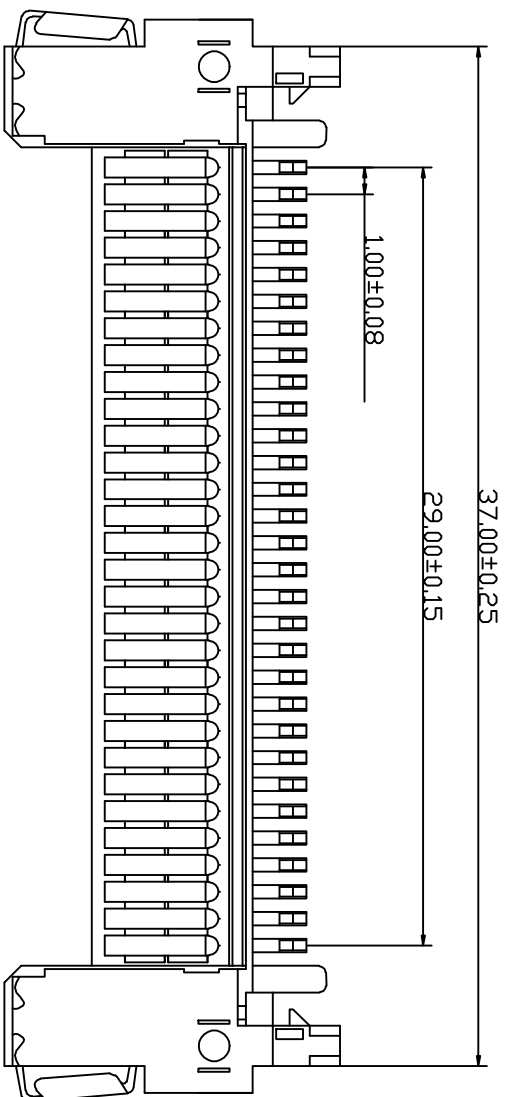

- SPECIFICATIONS
- Voltage rating: 200V AC, DC
 - Current rating: 1A, AC, DC
 - Withstanding Voltage: 500V AC/minute
 - Insulation resistance: 100MΩ min
 - Temperature range: -40℃~+85℃
 - Contact resistance: 20MΩ max
- HOUSING
- Part No: H1006AL-30
 - Material: Nylon 46 UL94V-0

4

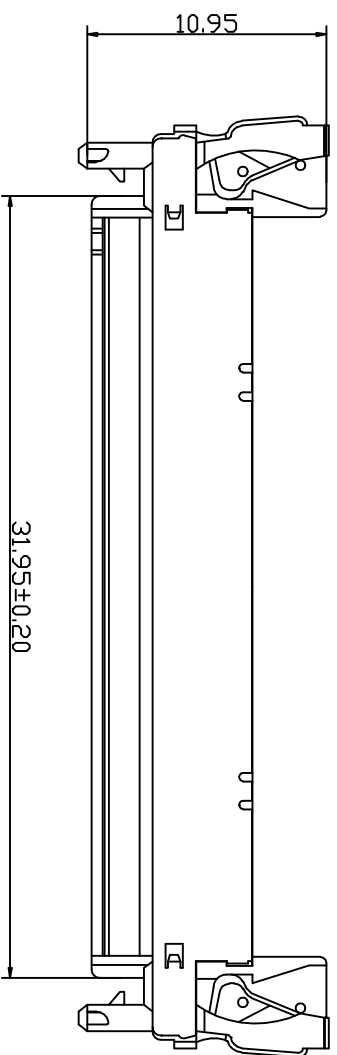

KLT 深圳市康利通电子科技有限公司

成品规格图

TOCERANCE

0±0.30

.0±0.25

.00±0.20

.000±0.015

TITLE	DATE	SCALE	VER No	SIZE
CHECKED BY	2016-04-08	1:1		
DRAWN BY	UNIT:mm		A	A4
李国常	PART No	H1006AL-30		

1

B

C

D

E

F

B

C

E

公差表

REV	ECN NO	LOCATIONS	DESCRIPTION	DATE	CHANGER
A			新版本	2016-04-08	李国常

4

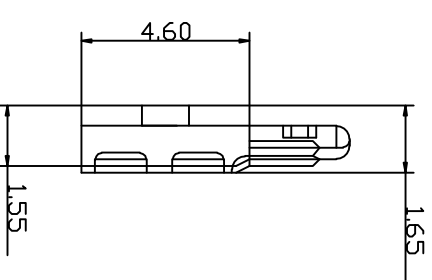
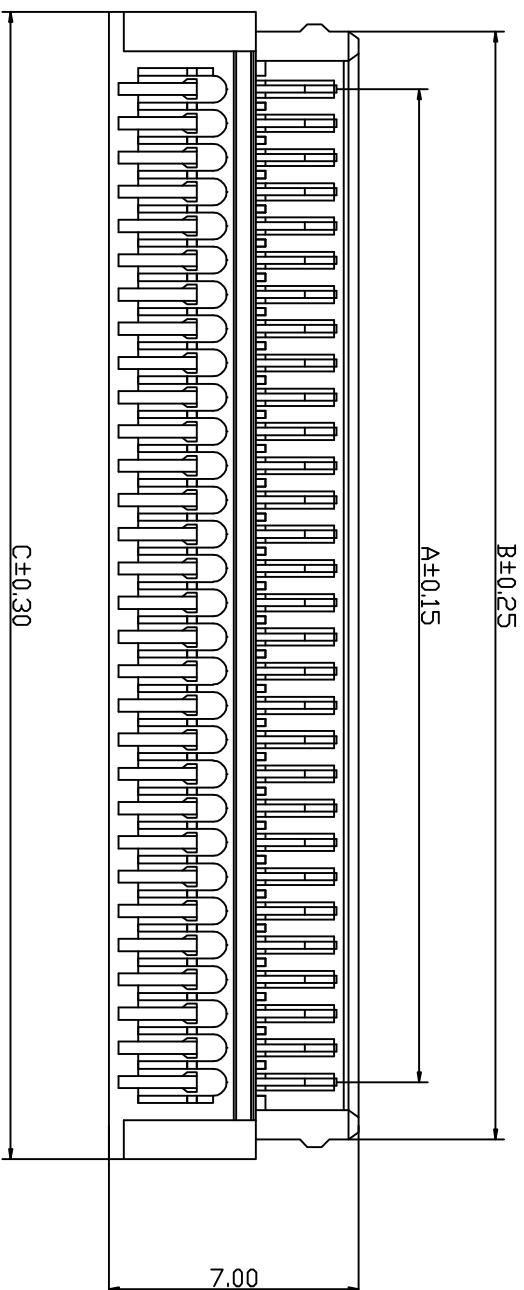
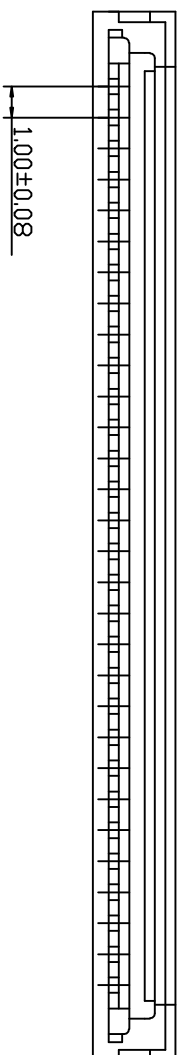

- SPECIFICATIONS
 - Voltage rating: 200V AC, DC
 - Current rating: 1A, AC, DC
 - Withstanding Voltage: 500V AC/minute
 - Insulation resistance: 100MΩ min
 - Temperature range: -40°C~+85°C
 - Contact resistance: 20MΩ max
- HOUSING
 - Part No: H1006A-NP
 - Poles: 20, 30
 - Material: Nylon 46 UL94V-0

Part No	Dimensions (mm)		
	A	B	C
H1006A-20	19.00	22.00	23.40
H1006A-30	29.00	32.00	33.40

KLT 深圳市康利通电子科技有限公司

TITLE

成品规格图

TOLERANCE

0±0.30

.0±0.25

.00±0.20

CHECKED BY

DATE

SCALE

.000±0.015

DRAWN BY

2016-04-08

1:1

VER No

SIZE

李国常

UNIT:mm



A

A4

李国常

PART NO

H1006A-NP

B

C

D

E

F

4

1

B

C

E

公差表

REV	ECN NO	LOCATIONS	DESCRIPTION	DATE	CHANGER
A			新版本	2016-04-08	李国常

4

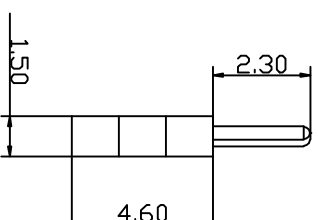
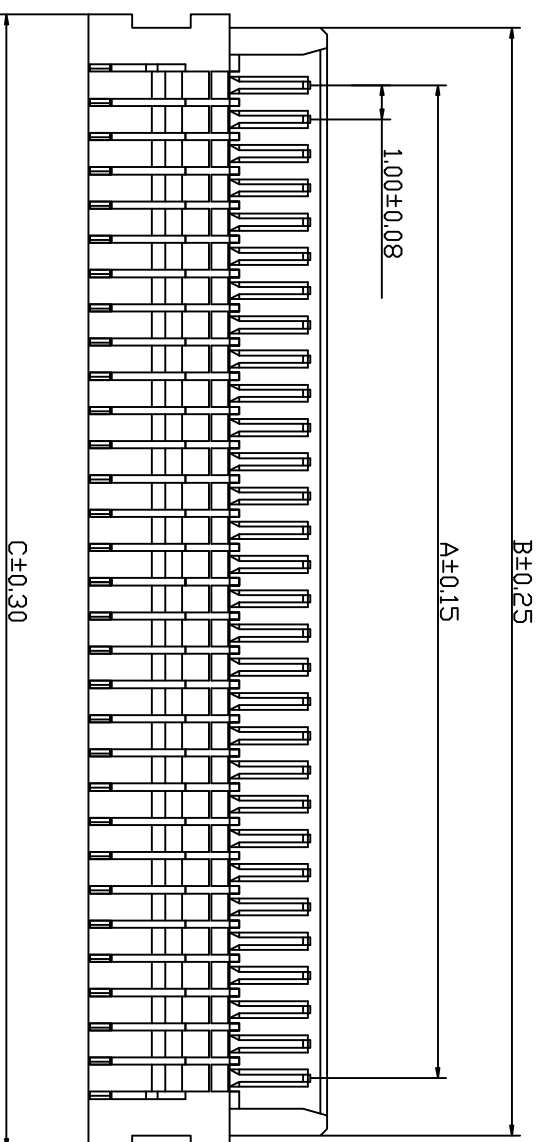

SPECIFICATIONS

- Voltage rating: 200V AC, DC
- Current rating: 1A, AC, DC
- Withstanding Voltage: 500V AC/minute
- Insulation resistance: 100MΩ min
- Temperature range: -40℃~+85℃
- Contact resistance: 20MΩ max

HOUSING

- Part No: H1006B-NP
- Poles: 20, 30
- Material: Nylon 46 UL94V-0

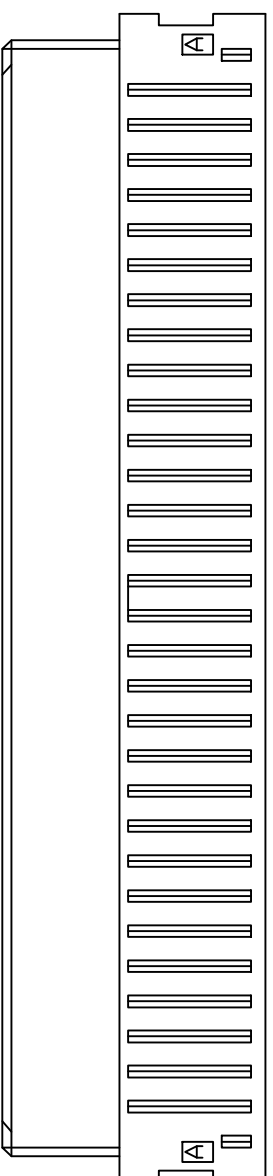
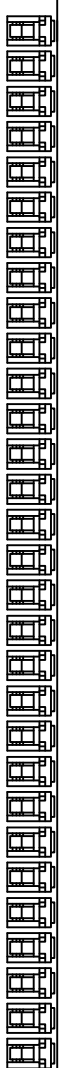

Part NO	Dimensions (mm)		
	A	B	C
H1006B-20	19.00	22.00	23.40
H1006B-30	29.00	32.00	33.40

KLIT 深圳市康利通电子科技有限公司

成品规格图

TOLERANCE

0±0.30

.0±0.25

.00±0.20

.000±0.015

1

TITLE	成品规格图			
CHECKED BY	DATE	SCALE	VER No	SIZE
	2016-04-08	1:1	A	A4
DRAWN BY	UNIT:mm			
李国常	PART NO	H1006B-NP		

B

C

D

E

F

4

B

C

E

公差表

REV	ECN NO	LOCATIONS	DESCRIPTION	DATE	CHANGER
A			新版本	2016-04-08	李国常

4

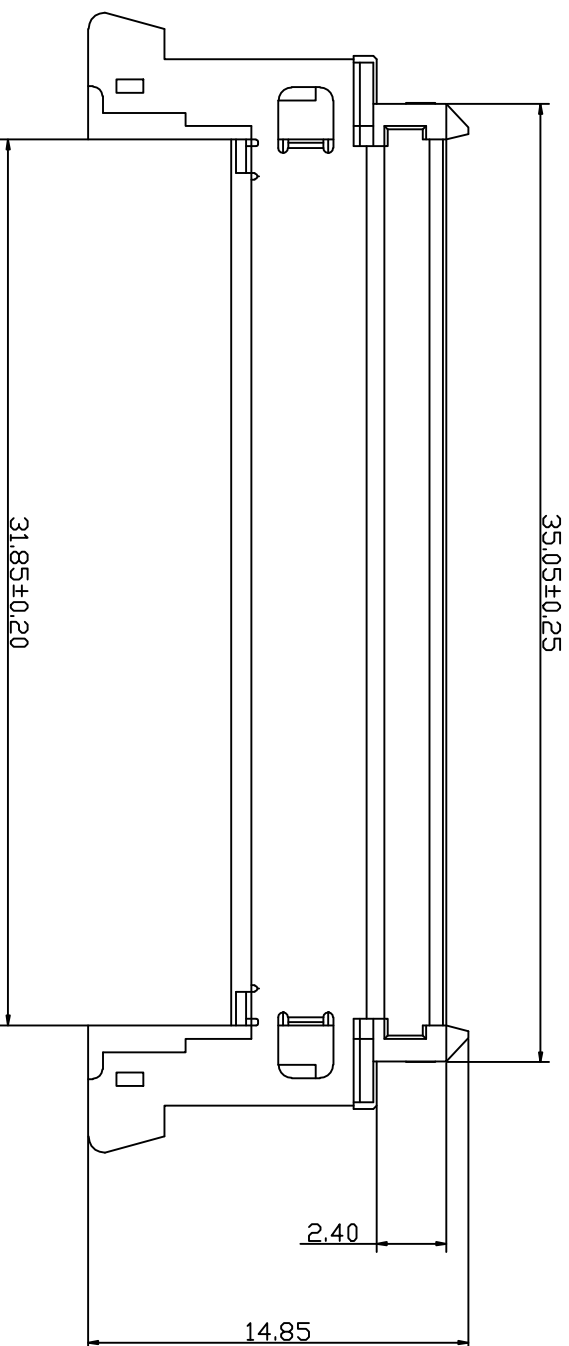

- SPECIFICATIONS
- Voltage rating: 200V AC, DC
 - Current rating: 1A, AC, DC
 - Withstanding Voltage: 500V AC/minute
 - Insulation resistance: 100MΩ min
 - Temperature range: -40℃~+85℃
 - Contact resistance: 20MΩ max
- HOUSING
- Part No: H1006E-30
 - Material: Nylon 46 UL94V-0

4

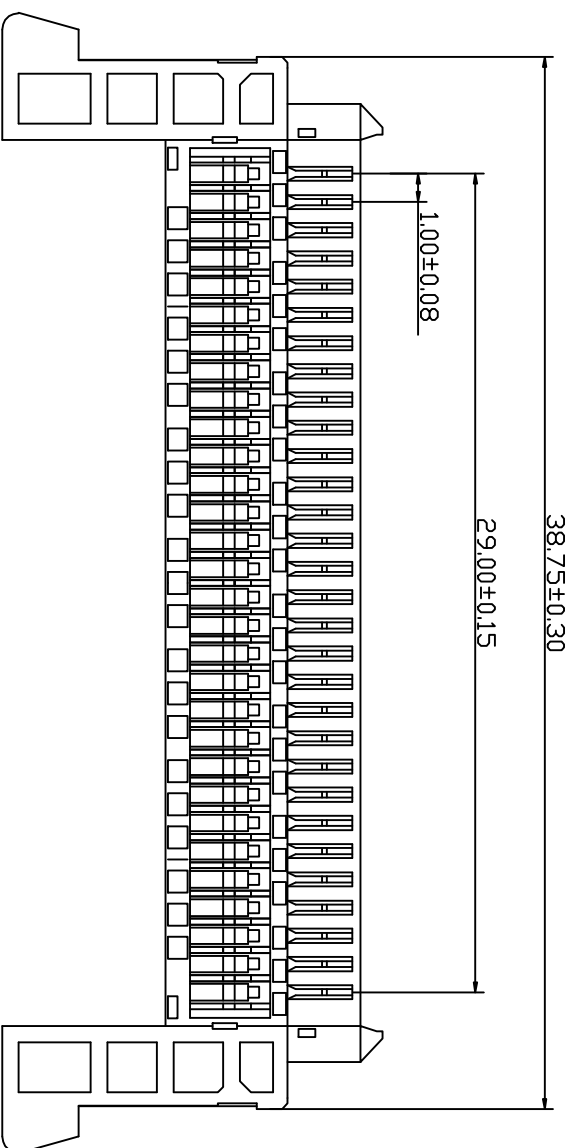
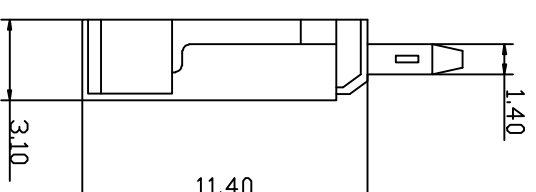
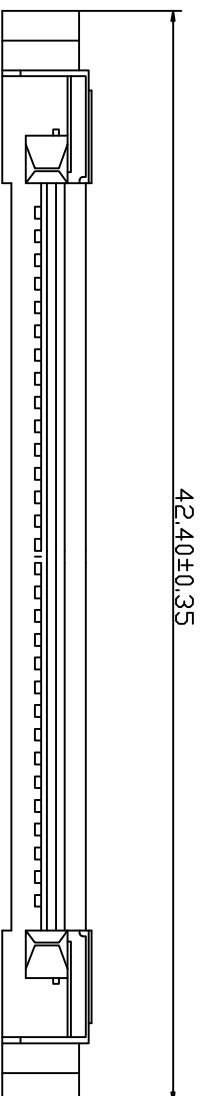

B

C

D

E

F

KLT 深圳市康利通电子科技有限公司

TOLERANCE

0±0.30

.0±0.25

.00±0.20

.000±0.015

TITLE	成品规格图		SCALE	VER No	SIZE
CHECKED BY	DATE	2016-04-08	1:1	A	A4
DRAWN BY	UNIT:mm				
李国常	PART No	H1006E-30			

1

B

C

E

公差表

REV	ECN NO	LOCATIONS	DESCRIPTION	DATE	CHANGER
A			新版本	2016-04-08	李国常

4

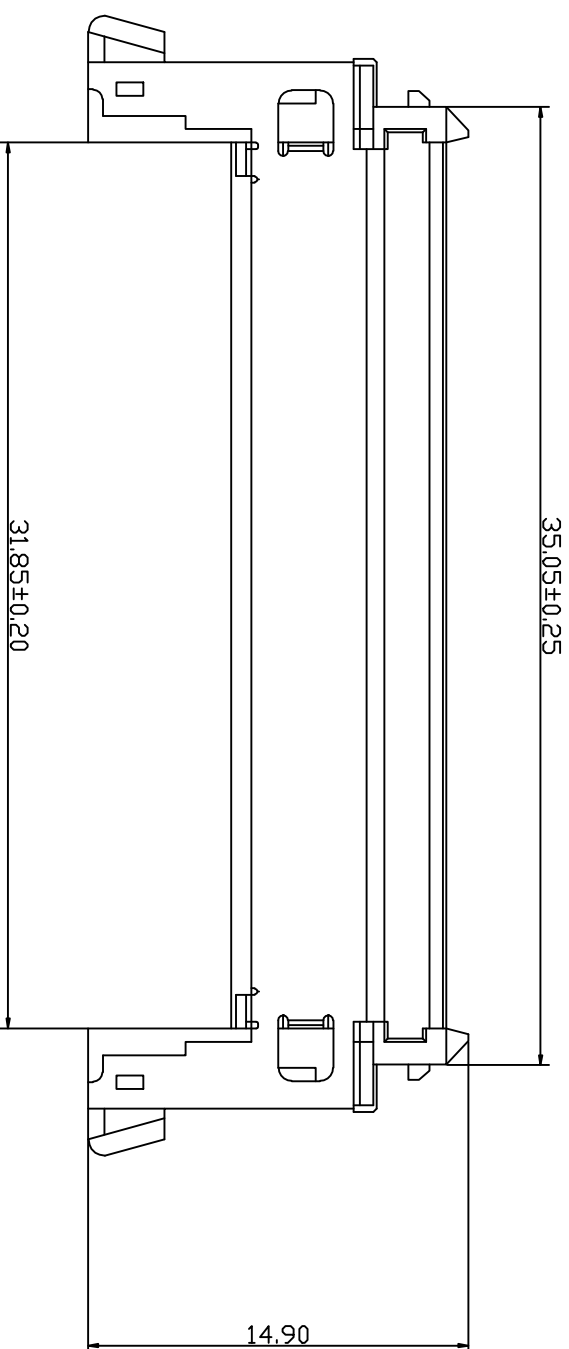

- SPECIFICATIONS**
- Voltage rating: 200V AC, DC
 - Current rating: 1A, AC, DC
 - Withstanding Voltage: 500V AC/minute
 - Insulation resistance: 100MΩ min
 - Temperature range: -40°C~+85°C
 - Contact resistance: 20MΩ max
- HOUSING**
- Part No: H1006EL-30
 - Material: Nylon 46 UL94V-0

42.65±0.35

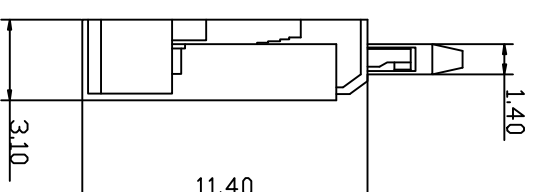
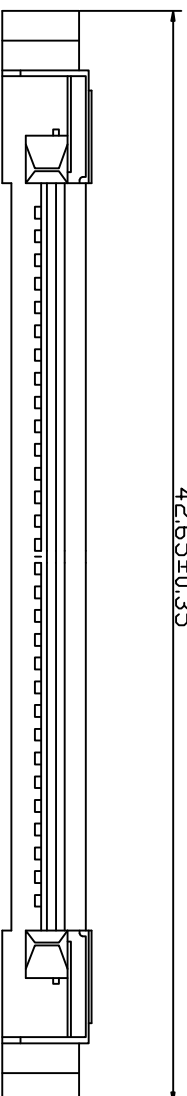

3.10

38.80±0.30

1.00±0.08

29.00±0.15

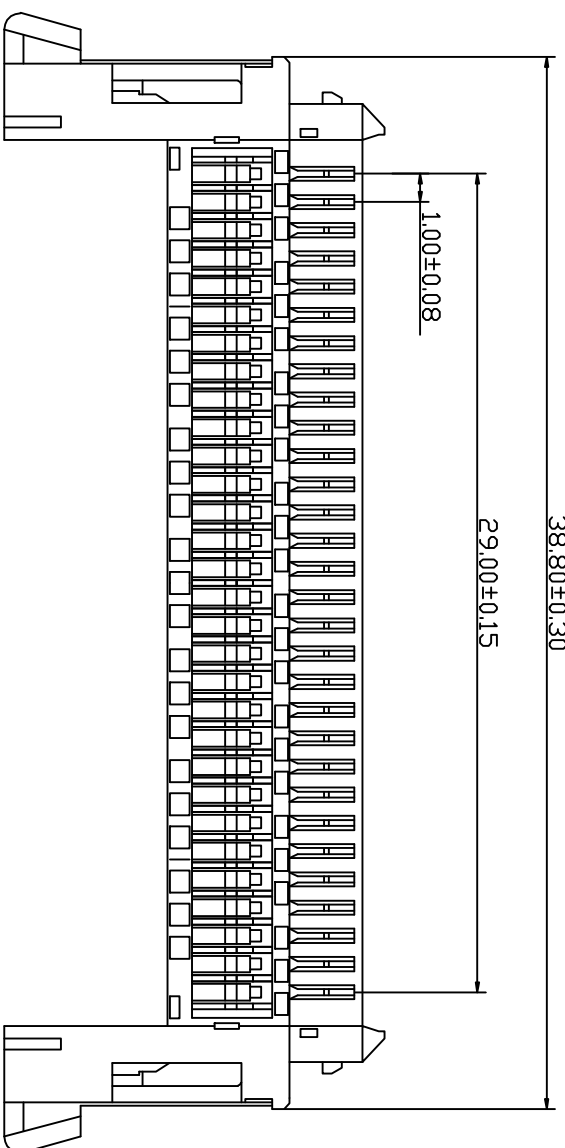

KLIT 深圳市康利通电子科技有限公司

成品规格图

Tolerance

0±0.30

.0±0.25

.00±0.20

.000±0.015

1

TITLE

CHECKED BY

DATE 2016-04-08

DRAWN BY

李国常

SCALE

1:1

UNIT:mm

PART No

H1006EL-30

VER No

A

SIZE

A4

B

C

D

E

F

4

B

C

E

公差表

REV	ECN NO	LOCATIONS	DESCRIPTION	DATE	CHANGER
A			新版本	2016-04-08	李国常

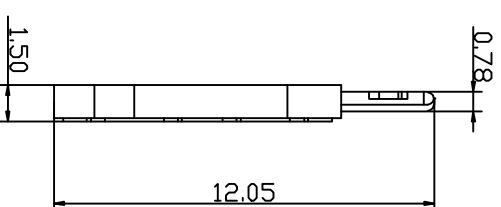
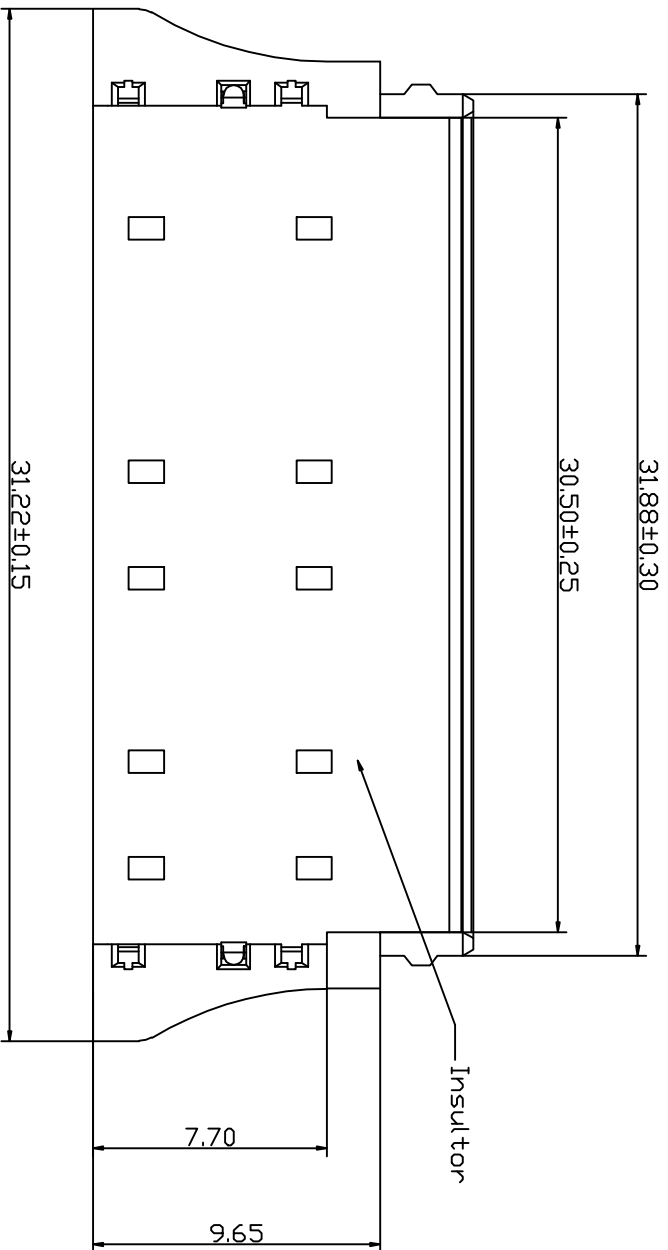

- SPECIFICATIONS**
- Voltage rating: 200V AC, DC
 - Current rating: 1A, AC, DC
 - Withstanding Voltage: 500V AC/minute
 - Insulation resistance: 100MΩ min
 - Temperature range: -40°C~+85°C
 - Contact resistance: 20MΩ max
- HOUSING**
- Part No: H1006F-30
 - Material: Nylon 46 UL94V-0

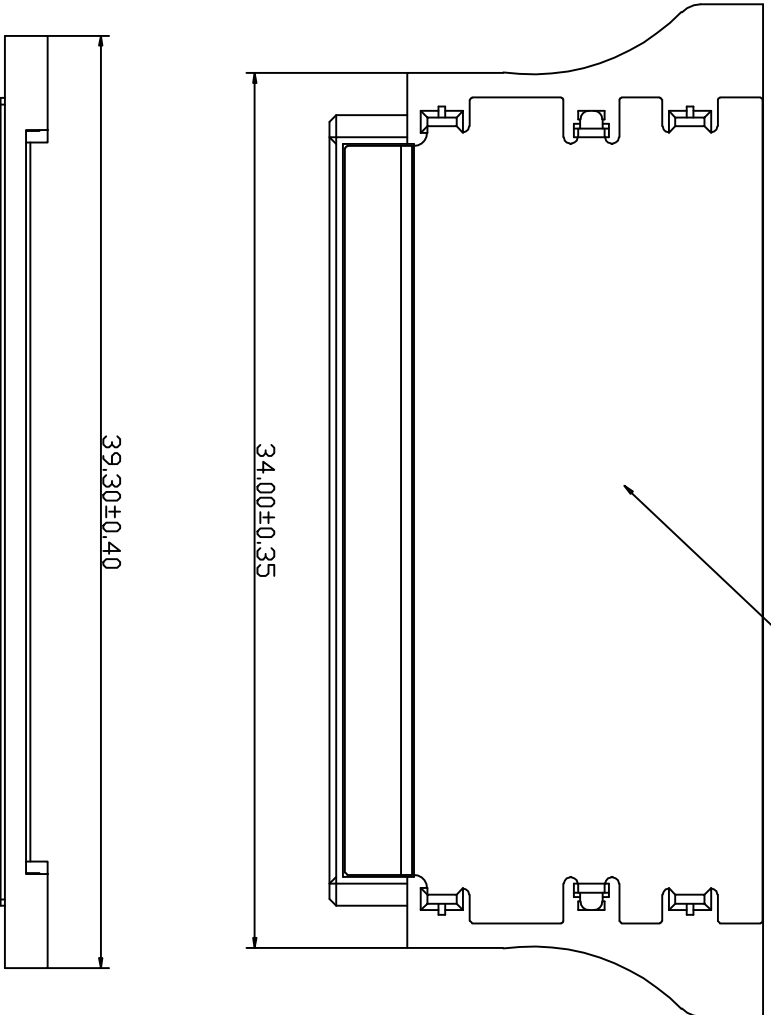

KLT 深圳市康利通电子科技有限公司

成品规格图

TOLERANCE

0±0.30

.0±0.25

.00±0.20

.000±0.015

TITLE	DATE	SCALE	VER No	SIZE
CHECKED BY	2016-04-08	1:1		
DRAWN BY	UNIT:mm		A	A4
李国常	PART No	H1006F-30		

4

4

1

B

C

D

E

F

B

C

E

公差表

REV	ECN NO	LOCATIONS	DESCRIPTION	DATE	CHANGER
A			新版本	2016-04-08	李国常

4

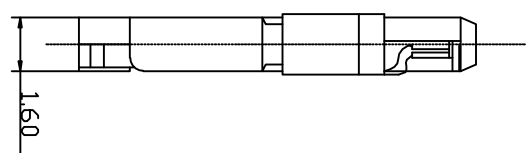
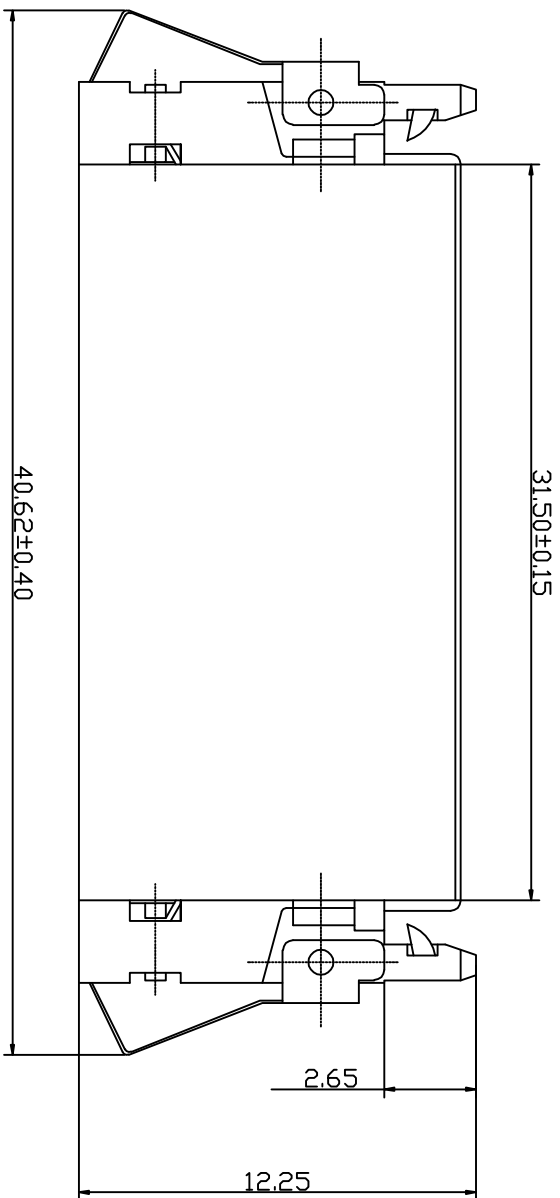

■ SPECIFICATIONS

- Voltage rating: 200V AC, DC
- Current rating: 1A, AC, DC
- Withstanding Voltage: 500V AC/minute
- Insulation resistance: 100MΩ min
- Temperature range: -40℃~+85℃
- Contact resistance: 20MΩ max

■ HOUSING

- Part No: H1006FL-30
- Material: Nylon 46 UL94V-0

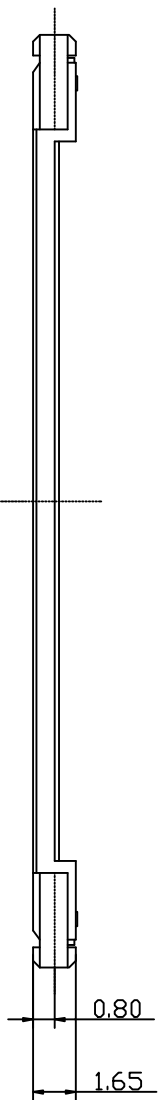
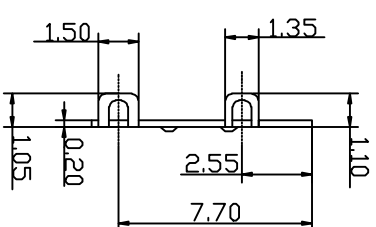
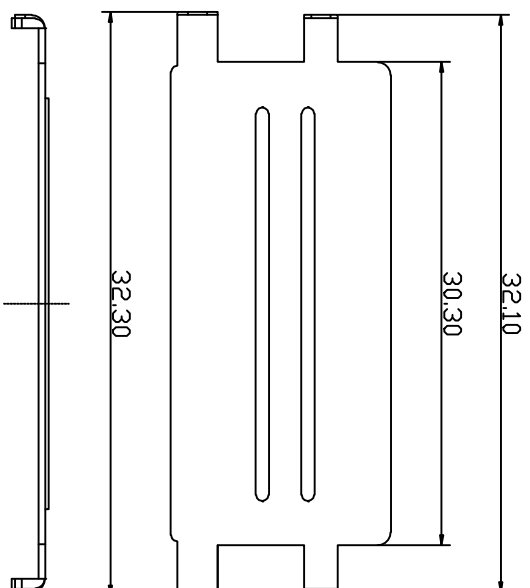
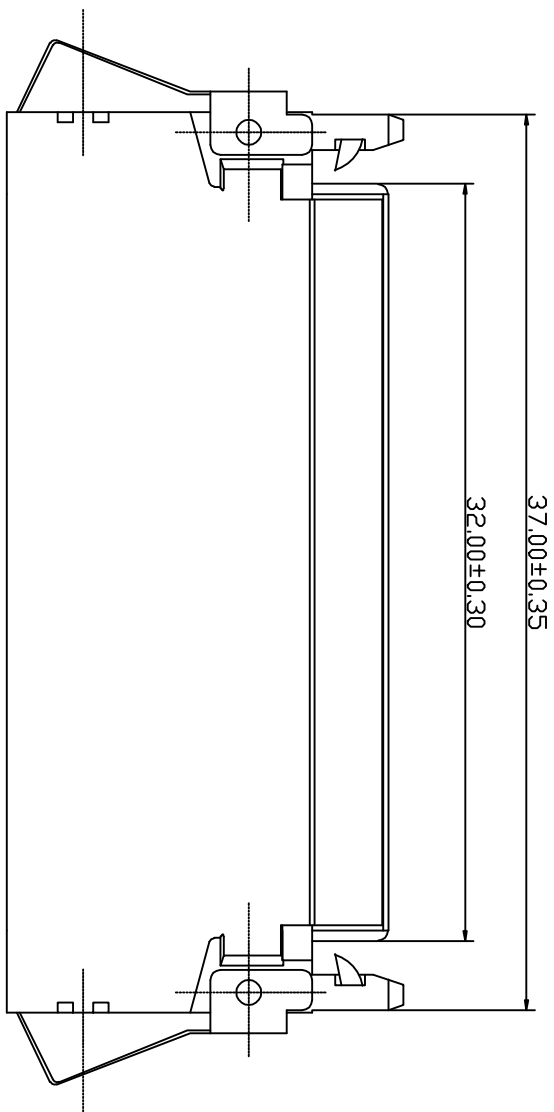

KLT 深圳市康利通电子科技有限公司

TOLERANCE

0±0.30

.0±0.25

.00±0.20

.000±0.015

成品规格图

TITLE

CHECKED BY

DATE

SCALE

2016-04-08

1:1

VER No

SIZE

DRAWN BY

UNIT:mm



A

A4

李国常

PART No

H1006FL-30

B

C

D

E

F

1

4

B

C

E

公差表

REV	ECN NO	LOCATIONS	DESCRIPTION	DATE	CHANGER
A			新版本	2016-04-08	李国常

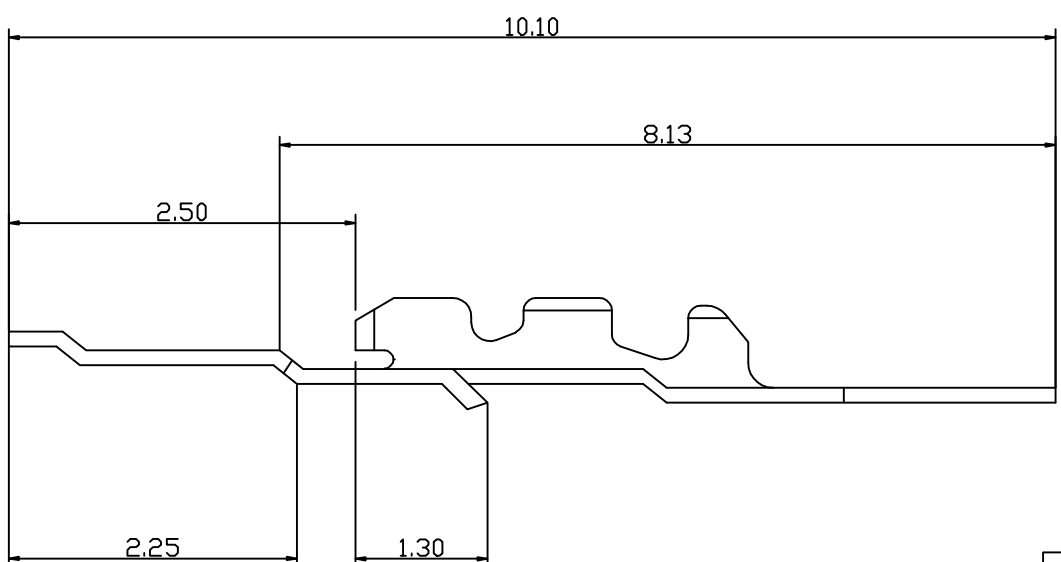
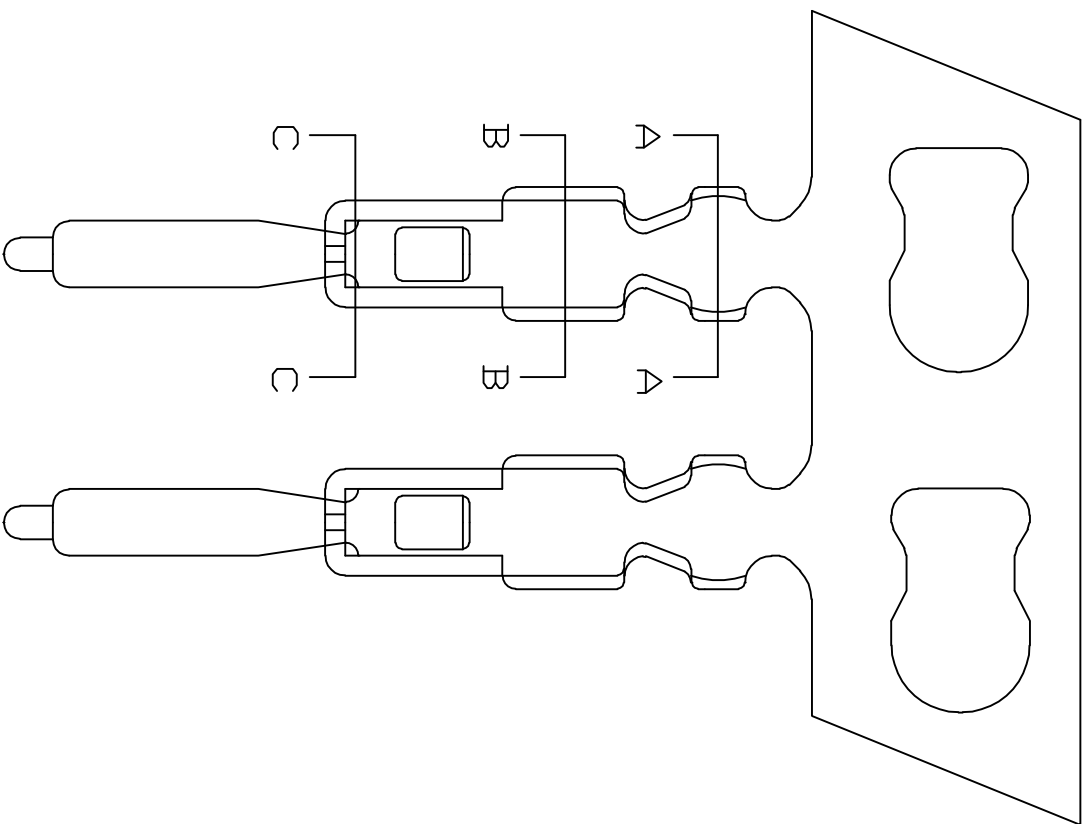

- SPECIFICATIONS**
- Voltage rating: 50V AC, DC
 - Current rating: 1A, AC, DC
 - Withstanding Voltage: 500V AC/minute
 - Insulation resistance: 100MΩ min
 - Temperature range: -40℃~+85℃
 - Contact resistance: 20MΩ max

- TERMINAL**
- Part No: T1006PG
 - Applicable wire: AWG#28-#32
 - Material: Phosphor Bronze
 - Finish: Gold-flash

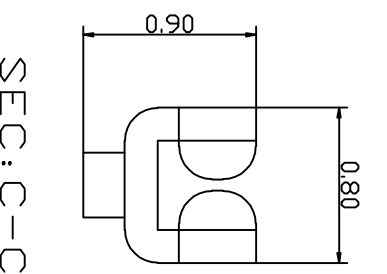
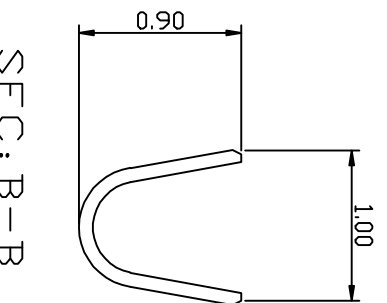
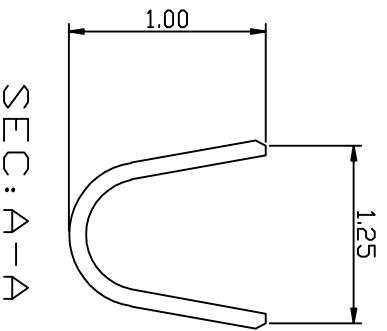

KLT 深圳市康利通电子科技有限公司

成品规格图

TOCERANCE

0±0.30

.0±0.25

.00±0.20

.000±0.015

VER No SIZE

A A4

TITLE

CHECKED BY

DATE 2016-04-08

DRAWN BY 李国常

UNIT:mm



SCALE 1:1

SCALE

SCALE

PART No

A

A4

T1006PG

4

4

B

C

D

E

F

1

B

C

E

公差表

REV	ECN NO	LOCATIONS	DESCRIPTION	DATE	CHANGER
A			新版本	2016-04-08	李国常

4

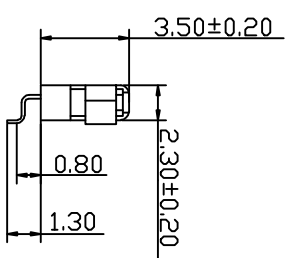
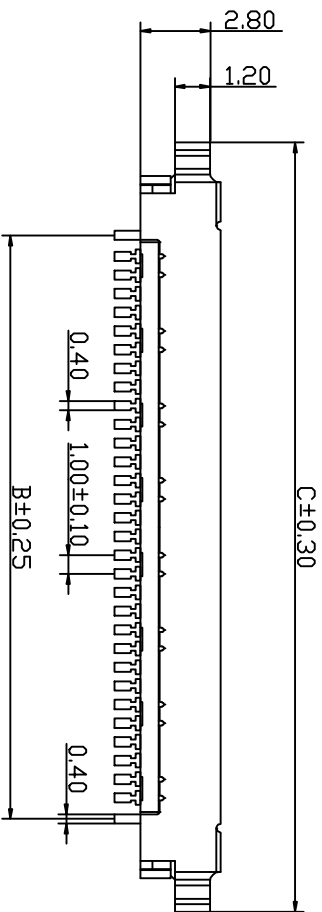
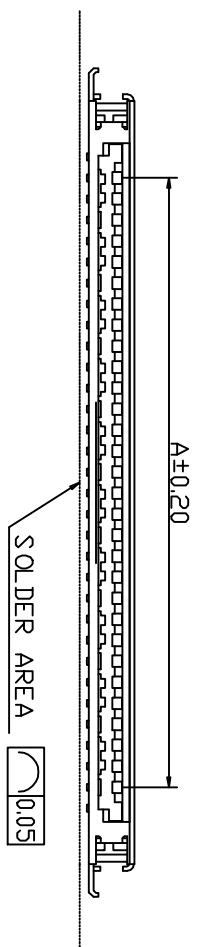

- SPECIFICATIONS**
- Voltage rating: 200V AC, DC
 - Current rating: 1A, AC, DC
 - Withstanding Voltage: 500V AC/minute
 - Insulation resistance: 100MΩ min
 - Temperature range: -40℃~+85℃
 - Contact resistance: 20MΩ max

WAFER

- Part No: W1006SR-NP
- Poles: 20, 30
- Material: Nylon 6T UL94V-0
- Ter Material: Phosphor Bronze /Gold-flash

Part No	Dimensions (mm)		
	A	B	C
W1006SR-20	19.00	21.00	26.65
W1006SR-30	29.00	31.00	36.65

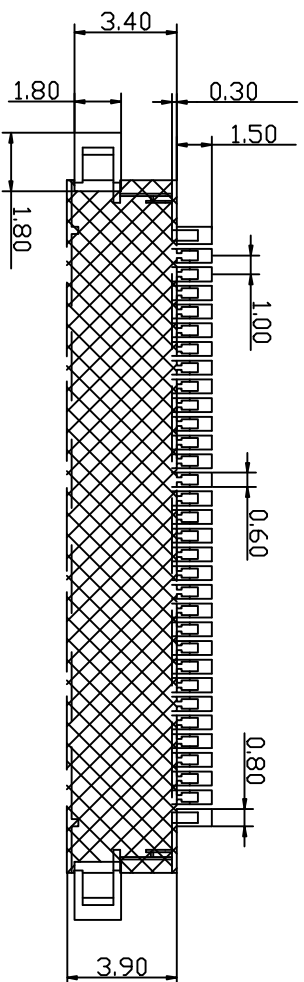

P.C.B. LAYOUT

KLT 深圳市康利通电子科技有限公司

成品规格图

TOLERANCE

- 0±0.30
- .0±0.25
- .00±0.20
- .000±0.015

TITLE	成品规格图		TOLERANCE	
CHECKED BY	DATE	SCALE	VER No	SIZE
DRAWN BY	UNIT:mm		A	A4
PART No	W1006SR-NP			

李国常

2016-04-08

1:1

W1006SR-NP

B

C

D

E

F

1

4