

版次: 1.0

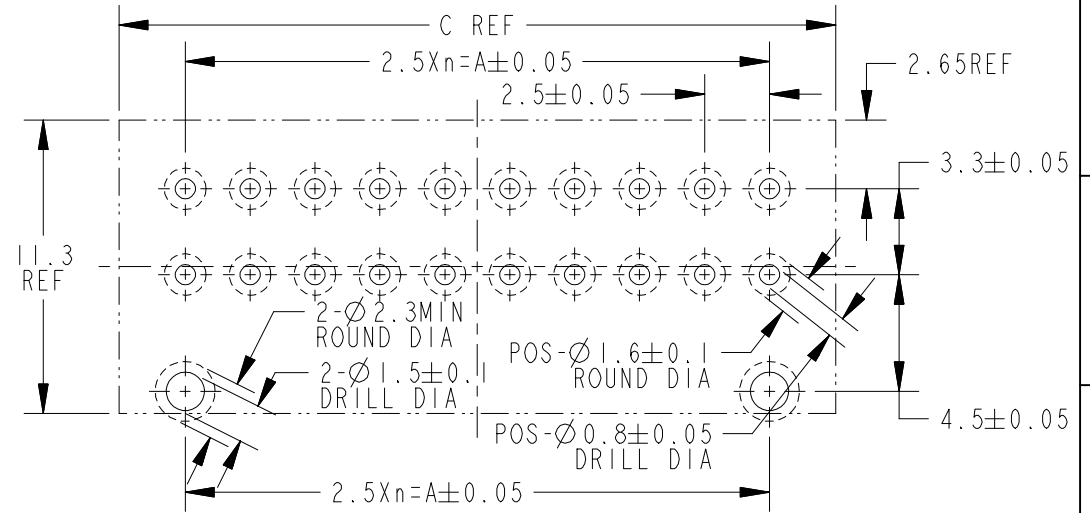

RECOMMEND PC BOARD HOLE PATTERN
: CONNECTOR MOUNT SIDE (NOT ACCUMULATE TOLERANCE)
PC BOARD THICKNESS : 1.0~1.6±0.1

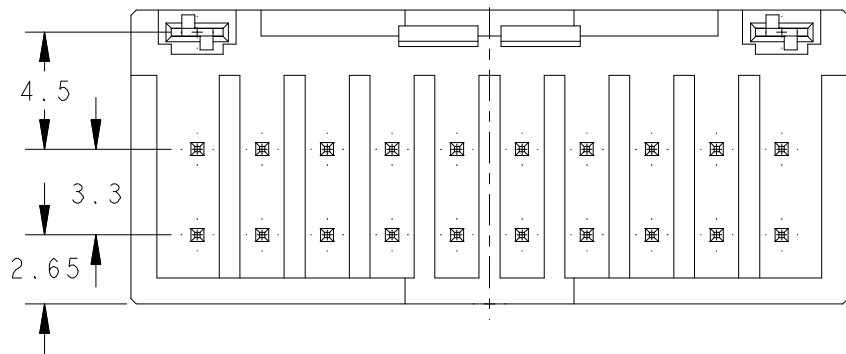
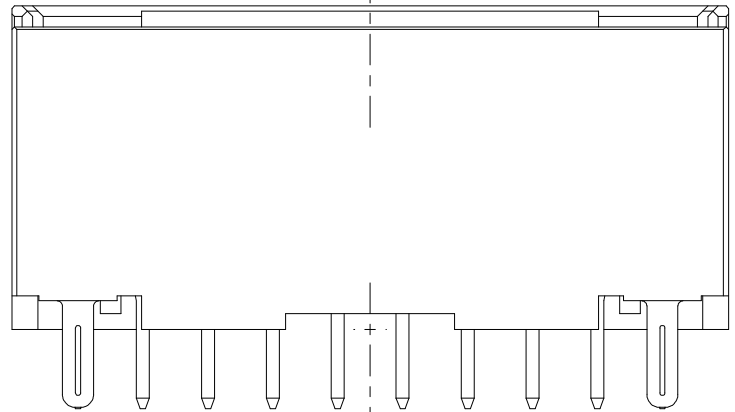
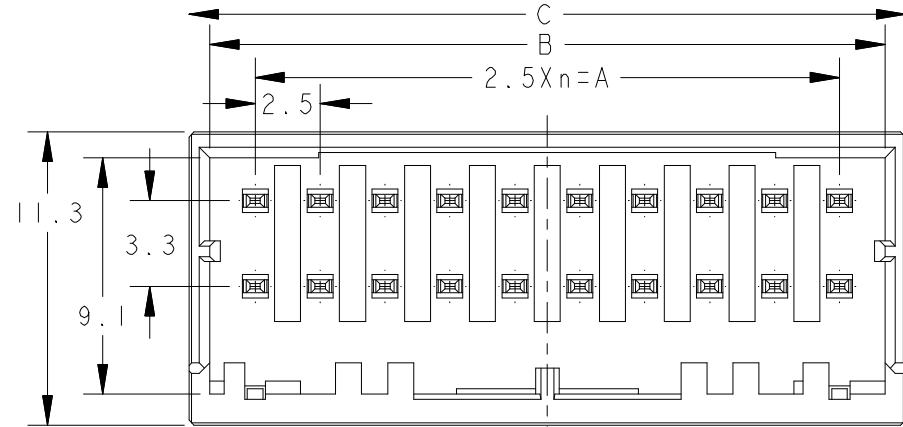
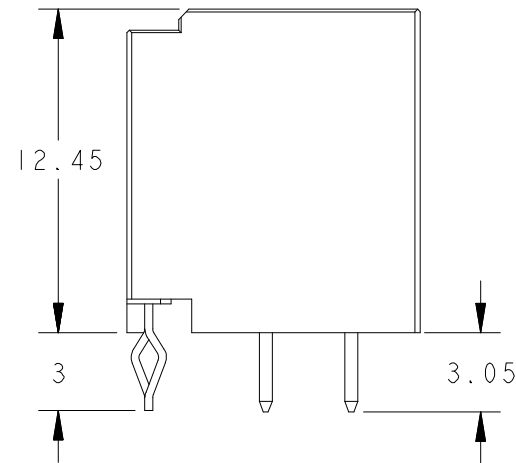

1. MATERIAL: HOUSING: GLASS FILLED THERMO PLASTIC POLYESTER (94V-0), COLOR: BLACK
CONTACT: COPPER ALLOY
RETENTION LEG: PRE-TIN COPPER

- FINISH (ALL OVER): NICKEL PL. 1.27μm MIN
- FINISH (CONTACT TAIL): TIN PL. 2μm MIN AFTER
- THE SHAPE, SIZE AND POSITION OF THE CHARACTER SHOW THE OUTLINE. THEY DON'T SHOW DETAILS.
- THE KEYING ARRANGEMENT OF "Y" IS SYMMETRIC WITH "X".

POS	n	A	B	C	KEY	PART NO
4P	1	2.5	6.0	7.6	X	KF7025-0204-2.5DIP
6P	2	5.0	8.5	10.1	X	KF7025-0306-2.5DIP
8P	3	7.5	11.0	12.6	X	KF7025-0408-2.5DIP
10P	4	10.0	13.5	15.1	X	KF7025-0510-2.5DIP
12P	5	12.5	16.0	17.6	X	KF7025-0612-2.5DIP
16p	7	17.5	21.0	22.6	X	KF7025-0816-2.5DIP
20P	9	22.5	26.0	27.6	X	KF7025-1020-2.5DIP

设计	李国常	序号	数量	材料	备注
校对					
审定	林振华				
客户型号					
第3角画法		标记	更改前数值	标记	更改前数值
更改日期					
产品材料/颜色		产品名称	胶壳	产品型号	KF7025-X2*X-2.5DIP
阶段标记		B	图纸编号		
共1页 第1页 比例 1:1 单位 mm 设计日期 2018-08-21					

版次: 1.0

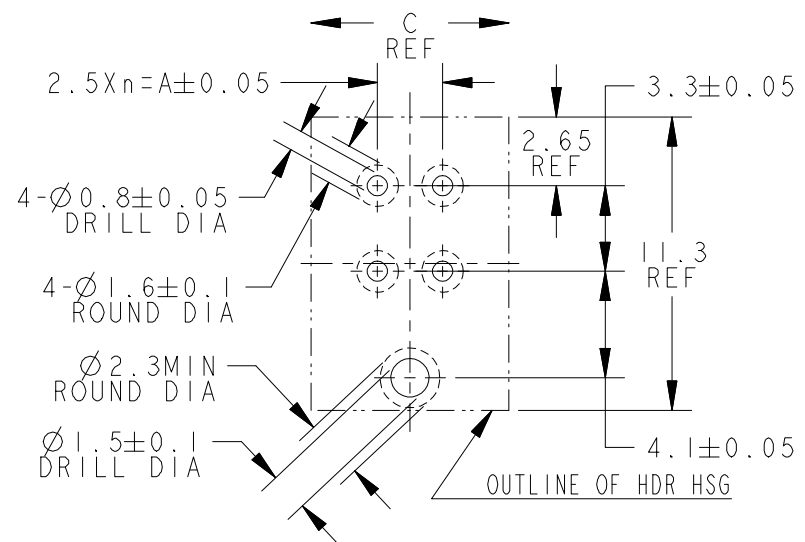
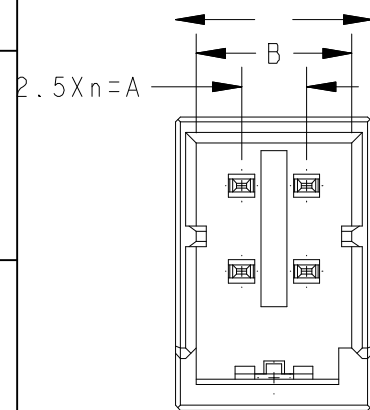

ONLY 4POS

RECOMMEND PC BOARD HOLE PATTERN
: CONNECTOR MOUNT SIDE (NOT ACCUMULATE TOLERANCE)
PC BOARD THICKNESS : 1.0~1.6±0.1

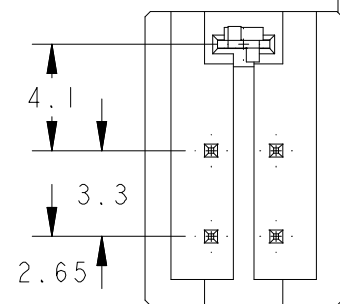
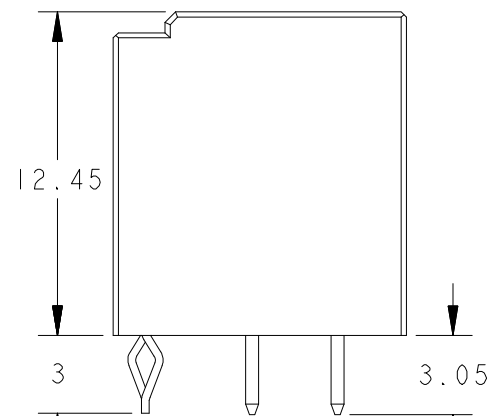
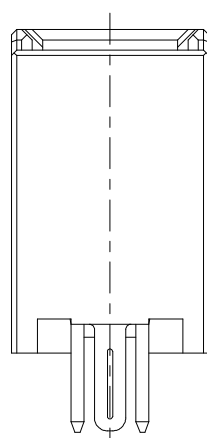

4POS (X-KEY) : KF7025-0204-2.5DIP

6POS (X-KEY) : KF7025-0306-2.5DIP

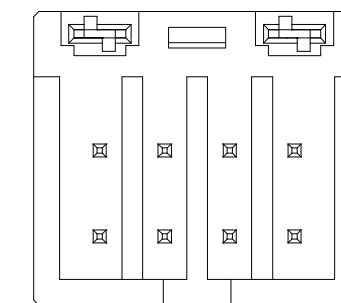
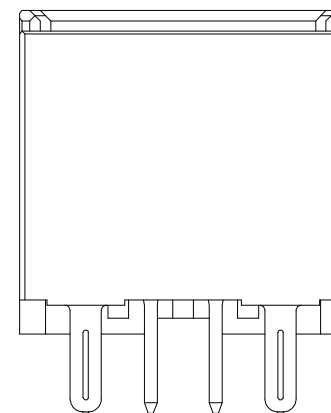
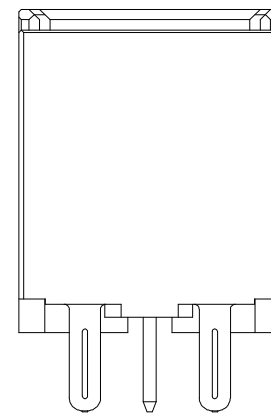
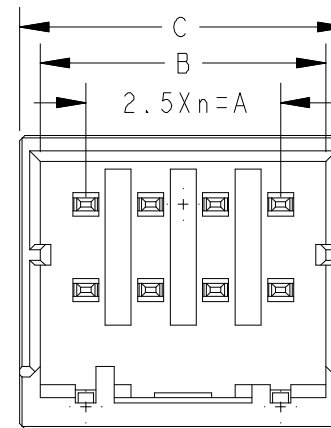
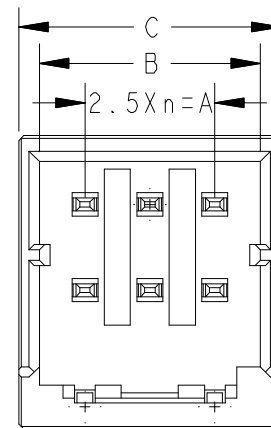

8POS (X-KEY) : KF7025-0408-2.5DIP

设计	李国常	序号	数量	材料	备注
校对					
审定	林振华				
客户型号					
第3角画法		标记	更改前数值	标记	更改前数值
产品材料/颜色		产品名称	胶壳	产品型号	
KT 深圳市康利通电子科技有限公司	阶段标记	B	图纸编号		
	共1页 第1页	比例 1:1	单位 mm	设计日期	2018-08-21

版次: 1.0

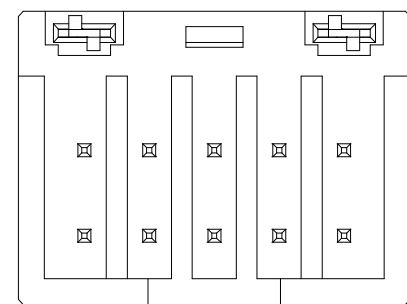
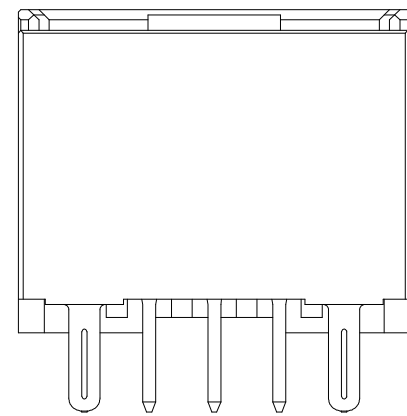
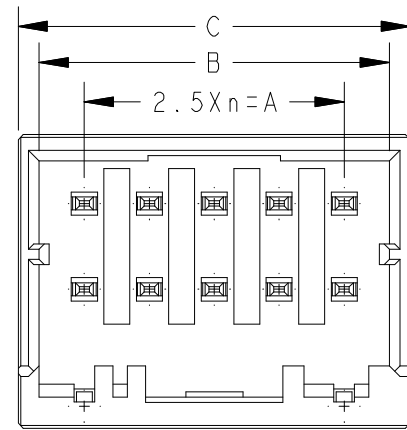

10POS(X-KEY):KF7025-0510-2.5DIP 12POS(X-KEY):KF7025-0612-2.5DIP

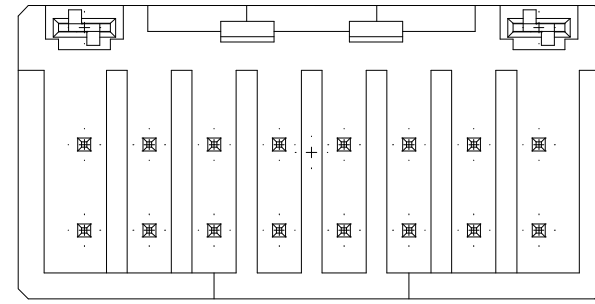
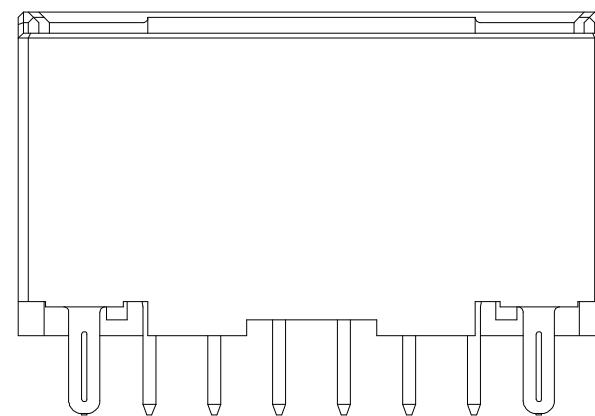
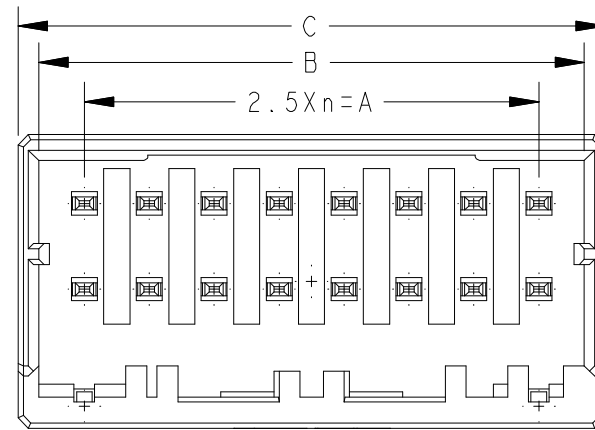
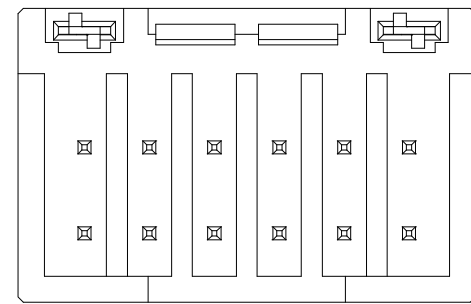
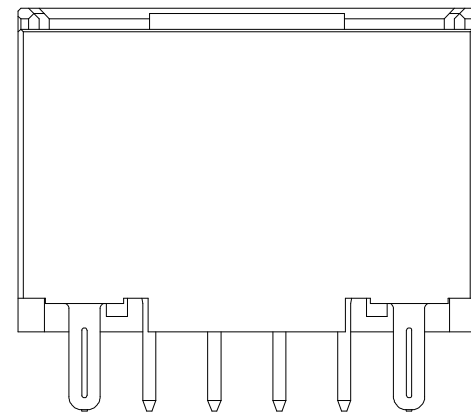
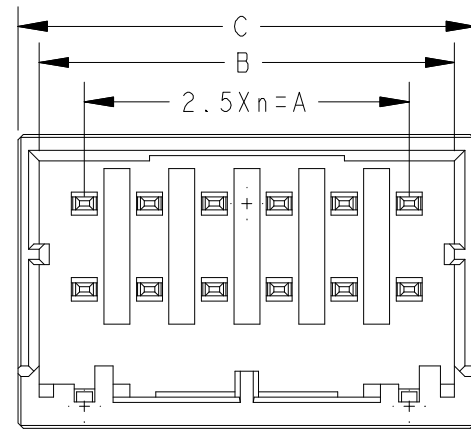

16POS(X-KEY):KF7025-0816-2.5DIP

3					
2					
1				PBT-GF	黑色
设计	李国常	序号	数量	材料	备注
校对					
审定	林振华				
客户型号					
第3角画法		标记	更改前数值	标记	更改前数值
更改日期					
产品材料/颜色		产品名称	胶壳	产品型号	
阶段标记		B	图纸编号		
共1页 第1页	比例	1:1	单位	mm	设计日期
					2018-08-21

KT 深圳市康利通电子科技有限公司