

版次: 1.0

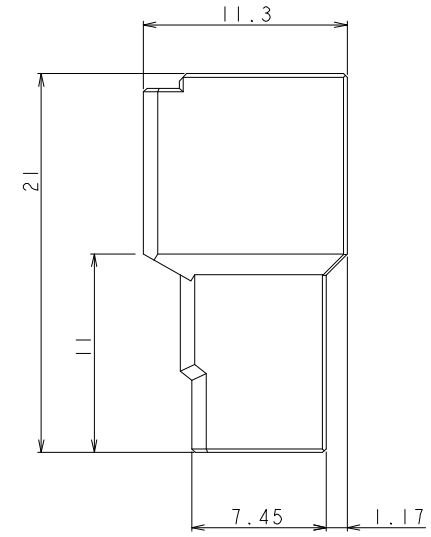

1. MATERIAL: GLASS FILLED THERMO PLASTIC POLYESTER(94V-0), COLOR: BLACK
2. THE SHAPE, SIZE AND POSITION OF THE CHARACTER SHOW THE OUTLINE. THEY DON'T SHOW DETAILS.
3. THE KEYING ARRANGEMENT OF "Y" IS SYMMETRIC WITH "X".

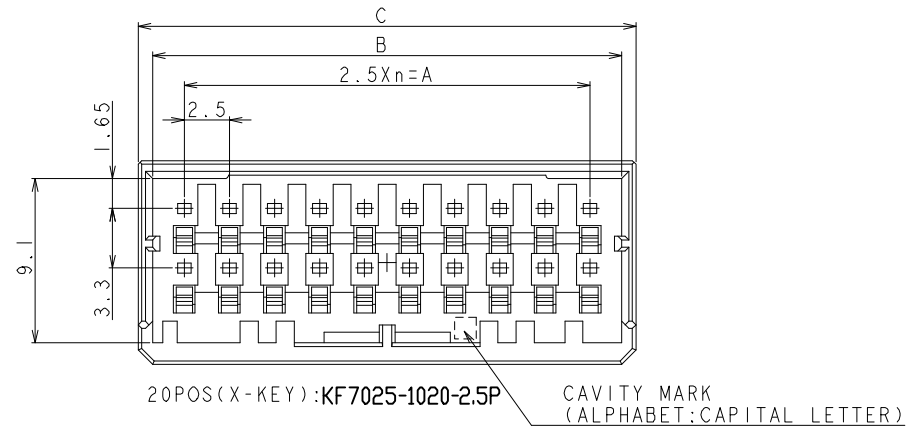
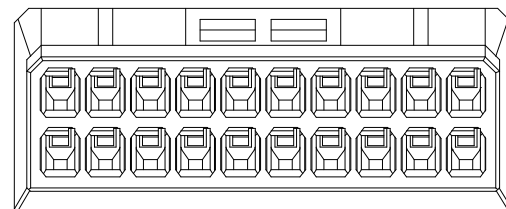
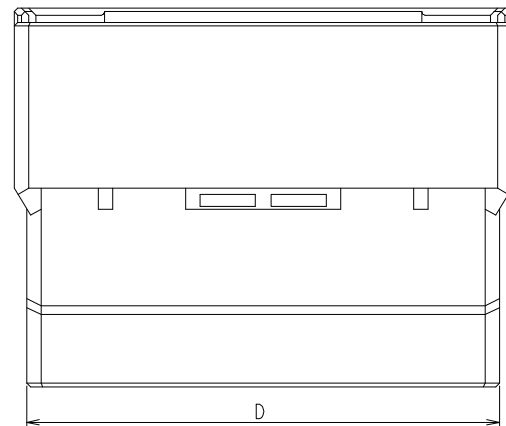

POS	n	A	B	C	D	PART NO
4P	1	2.5	5.9	7.6	3.1	KF7025-0204-2.5S
6P	2	5.0	8.4	10.1	3.3	KF7025-0306-2.5S
8P	3	7.5	10.9	12.6	3.3	KF7025-0408-2.5S
12P	5	12.5	15.9	17.6	8.3	KF7025-0612-2.5S
16P	7	17.5	20.9	22.6	8.3	KF7025-0816-2.5S
20P	9	22.5	25.9	27.6	8.3	KF7025-1020-2.5S

		3				
		2				
		1			PA66	黑色
设计	李国常	序号	数量	材料	备注	
校对						
审定	林振华					
客户型号						
第3角画法		标记	更改前数值	标记	更改前数值	更改日期
产品材料/颜色		产品名称	母胶壳	产品型号	KF7025-1020-2.5S	
KT 深圳市康利通电子科技有限公司		阶段标记	B	图纸编号		
		共1页 第1页	比例 1:1	单位 mm	设计日期	2018-07-30

版次: 1.0

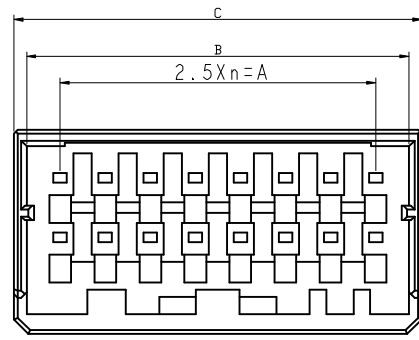

16 POS(X-KEY):KF7025-0816-2.5S

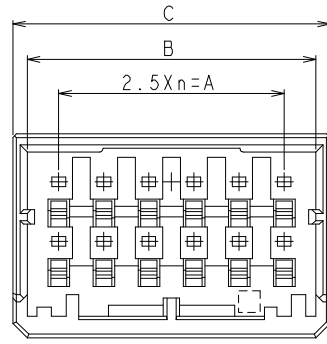
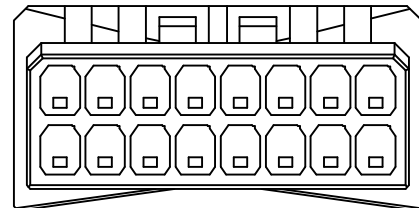
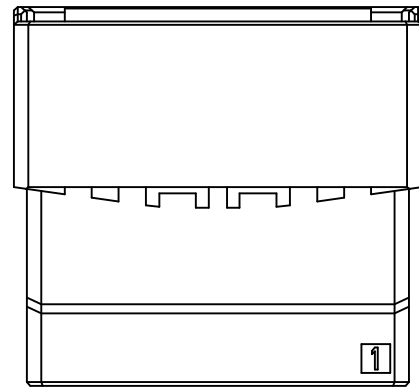

12 POS(X-KEY):KF7025-0612-2.5S

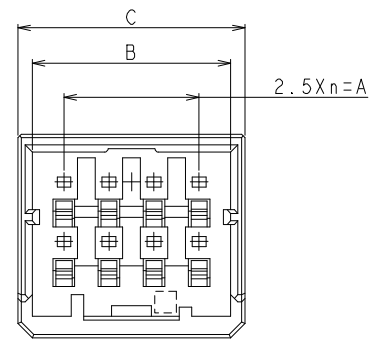
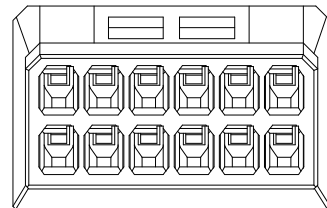
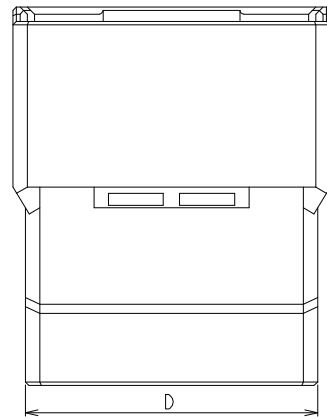

8 POS(X-KEY):KF7025-0408-2.5S

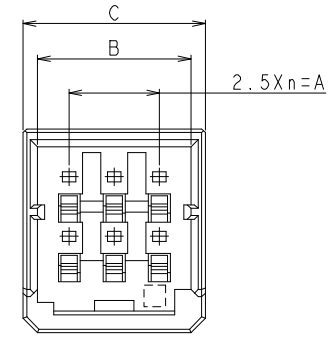
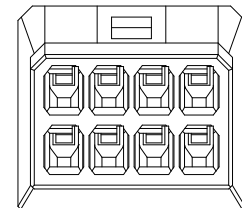
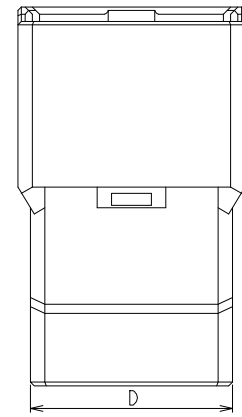

6 POS(X-KEY):KF7025-0306-2.5S

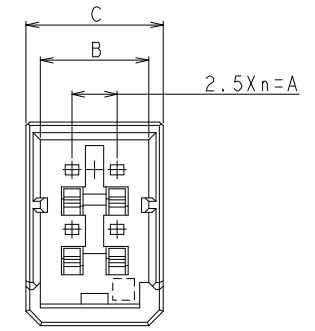
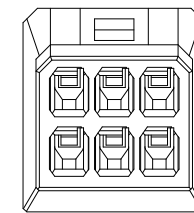
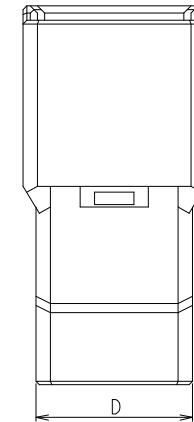

4 POS(X-KEY):KF7025-0204-2.5S

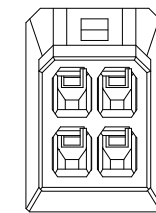
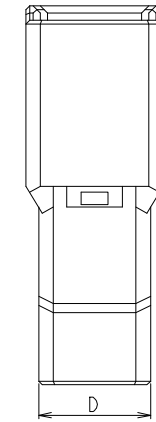

		3				
		2				
		1			PA66	黑色
设计	李国常	序号	数量	材料	备注	
校对						
审定	林振华					
客户型号						
第3角画法		标记	更改前数值	标记	更改前数值	更改日期
产品材料/颜色		产品名称	母胶壳	产品型号		
KT 深圳市康利通电子科技有限公司		阶段标记	B	图纸编号		
		共1页 第1页	比例 1:1	单位 mm	设计日期	2018-07-30