

版次: 1.0

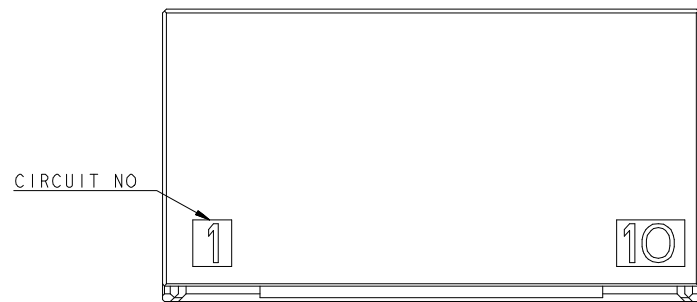

1. MATERIAL: HOUSING: GLASS FILED THERMO PLASTIC
POLYESTER(94V-0), COLOR: BLACK
CONTACT: COPPER ALLOY
RETENTION LEG: PRE-TIN COPPER ALLOY

- △. FINISH(ALL OVER): NICKEL PL. 1.27μmMIN
- △. FINISH(CONTACT AREA): GOLD PL. 0.38μmMIN AFTER △
- △. FINISH(CONTACT TAIL): TIN PL. 2μmMIN AFTER △
- 5. THE SHAPE, SIZE AND POSITION OF THE CHARACTER SHOW THE OUTLINE. THEY DON'T SHOW DETAILS.
- 6. THE KEYING ARRANGEMENT OF "Y" IS SYMMETRIC WITH "X".

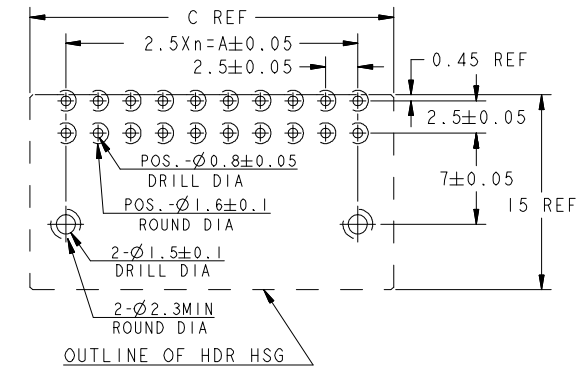

RECOMMEND PC BOARD HOLE PATTERN
: CONNECTOR MOUNT SIDE (NOT ACCUMULATE TOLERANCE)
PC BOARD THICKNESS : 1.0~1.6±0.1

AS SHOWN : KF7025-20W-2.5AWG (20POS:X-KEY)
ONLY 4POS----SEE SHEET 2 OF 3

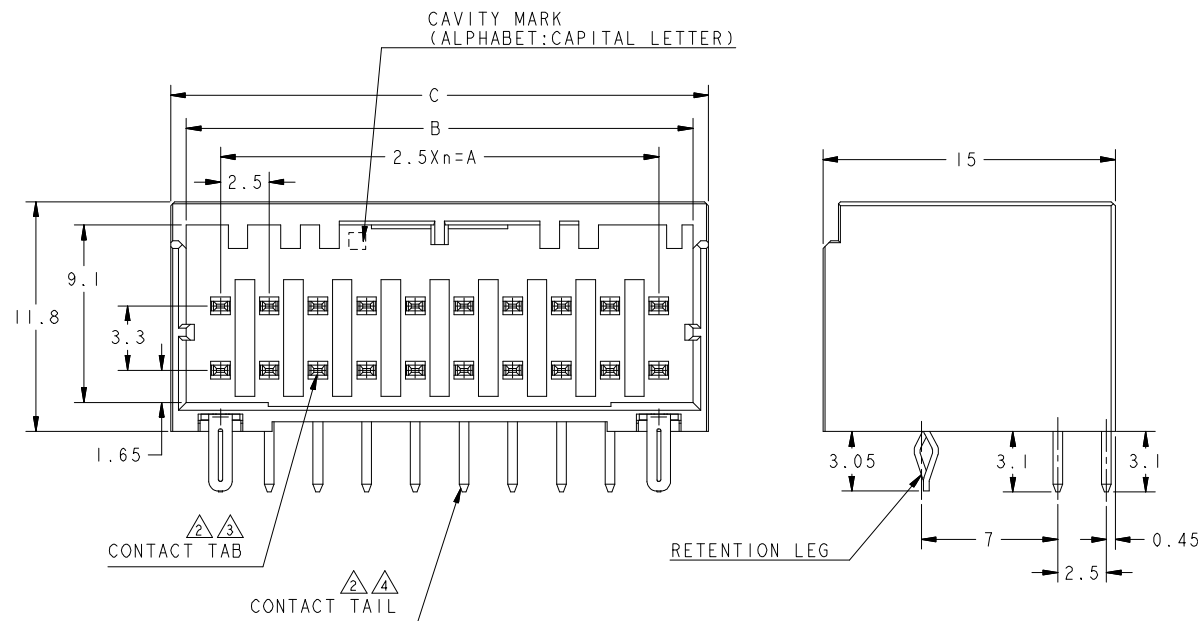

KF7025-20W-2.5AWG
(20POS:X-KEY)

POS	n	A	B	C	KEY	PART NO
4P	1	2.5	6.0	7.6	X	KF7025-04W-2.5AWG
6P	2	5.0	8.5	10.1	X	KF7025-06W-2.5AWG
8P	3	7.5	11.0	12.6	X	KF7025-08W-2.5AWG
12P	5	12.5	16.0	17.6	X	KF7025-12W-2.5AWG
16p	7	17.5	21.0	22.6	X	KF7025-16W-2.5AWG
20P	9	22.5	26.0	27.6	X	KF7025-20W-2.5AWG

		3				
		2				
		1			PBT-GF	黑色
设计	李国常	序号	数量	材料	备注	
校对						
审定	林振华					
客户型号						
第3角画法		标记	更改前数值	标记	更改前数值	更改日期
产品材料/颜色		产品名称	胶壳	产品型号	KF7025-20W-2.5AWG	
KT 深圳市康利通电子科技有限公司		阶段标记	B	图纸编号		
		共1页 第1页	比例 1:1	单位 mm	设计日期	2018-10-21

版次: 1.0

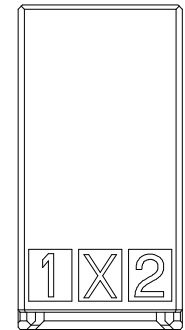

KF7025-04W-2.5AWG
(4POS: X-KEY)

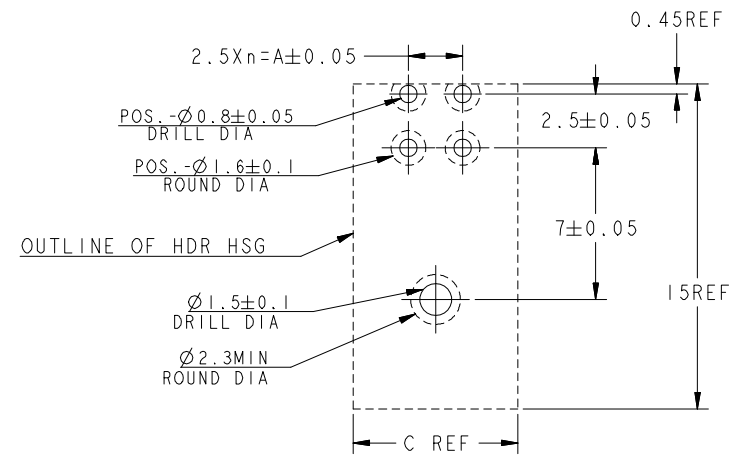

RECOMMEND PC BOARD HOLE PATTERN
: CONNECTOR MOUNT SIDE (NOT ACCUMULATE TOLERANCE)
PC BOARD THICKNESS : $1.0\sim 1.6\pm 0.1$

ONLY 4POS

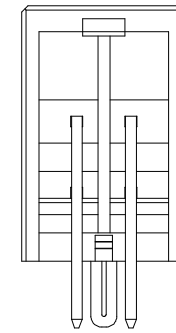
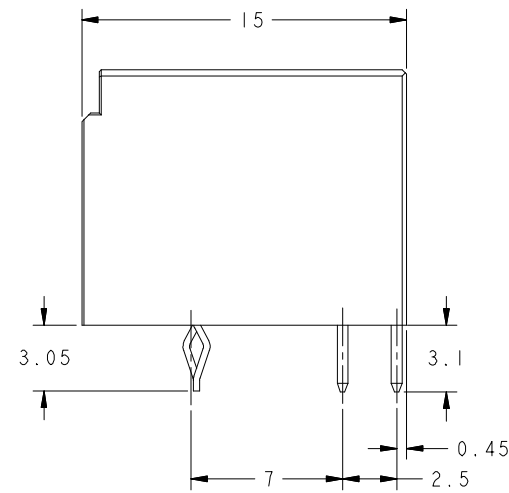
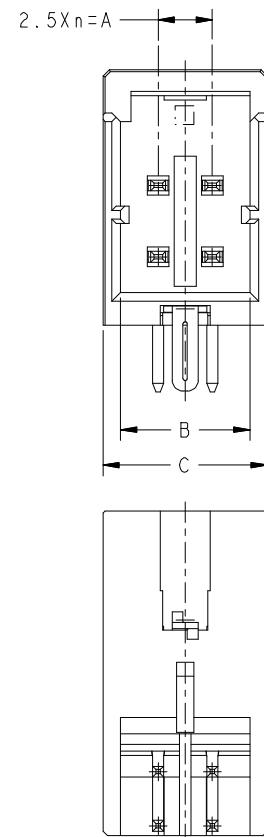

3					
2					
1			PBT-GF	黑色	
设计	李国常	序号	数量	材料	备注
校对					
审定	林振华				
客户型号					
第3角画法		标记	更改前数值	标记	更改前数值
更改日期					
产品材料/颜色		产品名称	胶壳	产品型号	KF7025-04W-2.5AWG
阶段标记		B	图纸编号		
共1页 第1页	比例	1:1	单位	mm	设计日期
					2018-10-21

KT 深圳市康利通电子科技有限公司

版次: 1.0

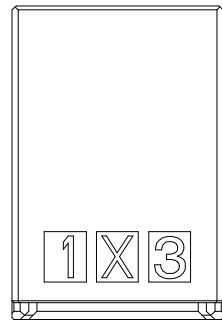

KF7025-06W-2.5AWG
(6POS:X-KEY)

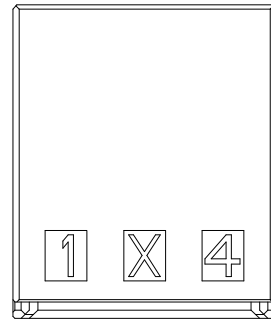
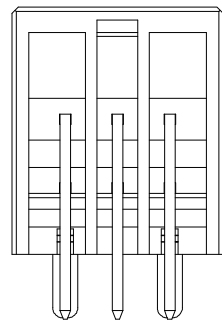
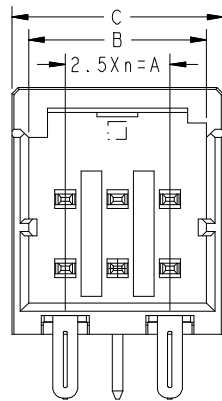

KF7025-08W-2.5AWG
(8POS:X-KEY)

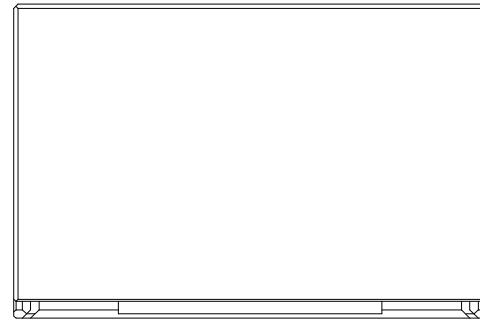
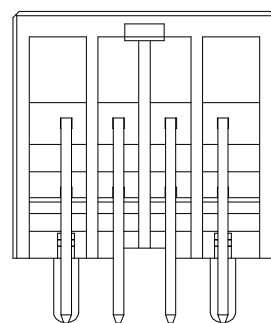
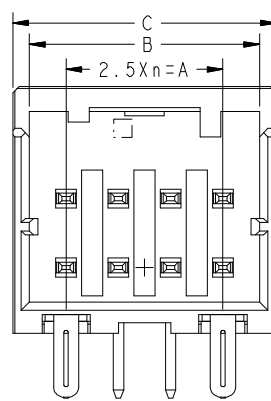

KF7025-16W-2.5AWG

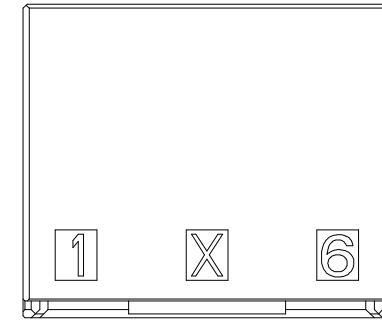
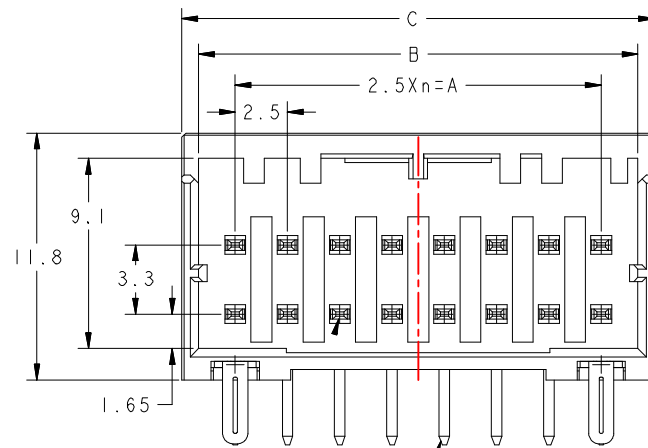

KF7025-12W-2.5AWG
(12POS:X-KEY)

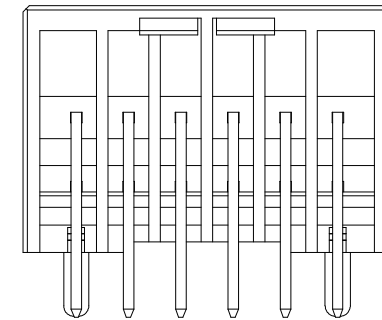
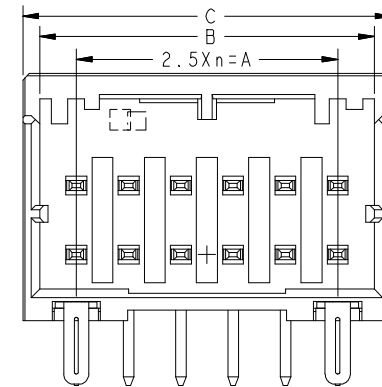

		3			
		2			
		1		PBT-GF	黑色
设计	李国常	序号	数量	材料	备注
校对					
审定	林振华				
客户型号					
第三角画法		标记	更改前数值	标记	更改前数值
更改日期					
产品材料/颜色		产品名称	胶壳	产品型号	
		阶段标记	B	图纸编号	
深圳市康利通电子科技有限公司		共1页 第1页	比例 1:1	单位 mm	设计日期 2018-10-21