

版次: 1.0

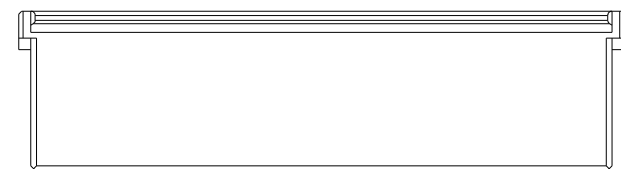
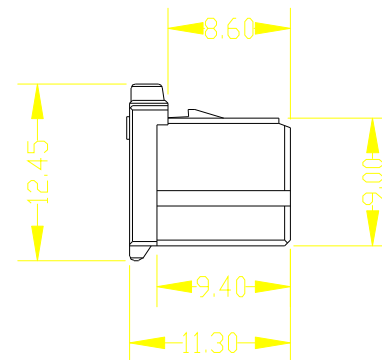
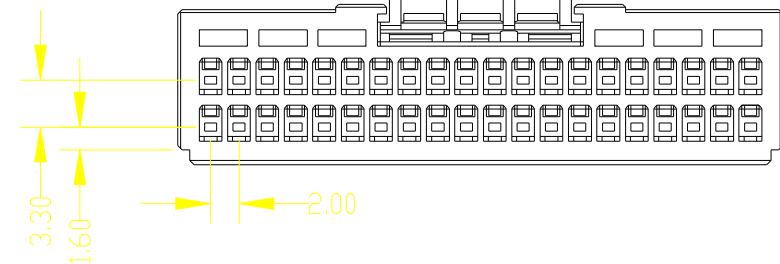
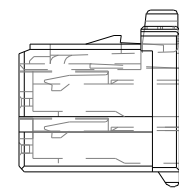
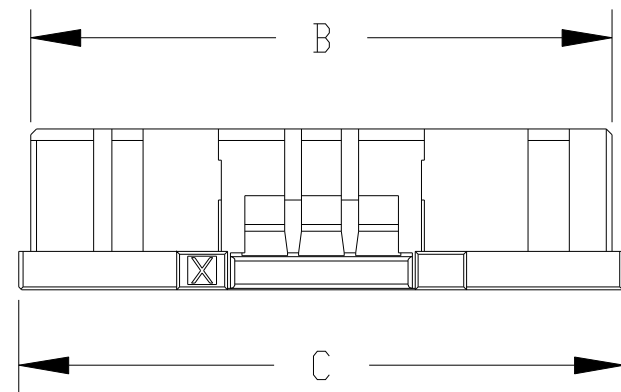
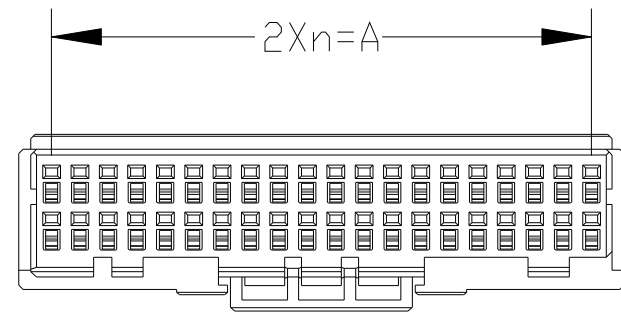

- 1 . MATERIAL:GLASS FILED THERMO PLASTIC
POLYESTER(94V-0), COLOR:BLACK
- 2 . THE SHAPE, SIZE AND POSITION OF THE CHARACTER
SHOW THE OUTLINE. THEY DON'T SHOW DETAILS.
- 3 . DIFFERENT HEIGHT OF LOCK PROTECTOR.
A FINGERTIP IS STOOD AND PUSHED
WHEN OPERATING A LOCK LEVER

POS	n	A	B	C	KEY	PART NO
10P	4	8.0	10.9	12.6	X	KF 7020-0510-2.0P
20P	9	18.0	20.9	22.6	X	KF 7020-1020-2.0P
22P	10	20.0	22.9	24.6	X	KF 7020-1122-2.0P
26P	12	24.0	26.9	28.6	X	KF 7020-1326-2.0P
28P	13	26.0	28.9	30.6	X	KF 7020-1428-2.0P
30P	14	28.0	30.9	32.6	X	KF 7020-1530-2.0P
32P	15	30.0	32.9	34.6	X	KF 7020-1632-2.0P
34P	16	32.0	34.9	36.6	X	KF 7020-1734-2.0P
40P	19	38.0	40.9	42.6	X	KF 7020-2040-2.0P

设计	李国常	序号	数量	材料	颜色
校对				PA-GF	黑色
审定	林振华				
客户型号					
第三角画法		标记	更改前数值	标记	更改前数值
产品材料/颜色		产品名称	胶壳	产品型号	KF 7020-2040-2.0P
深圳市康利通电子科技有限公司		阶段标记	B	图纸编号	
		共1页 第1页	比例 1:1	单位 mm	设计日期 2019-01-03

版次: 1.0

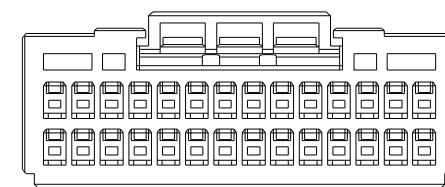
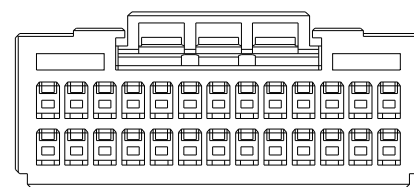
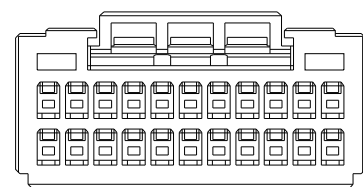
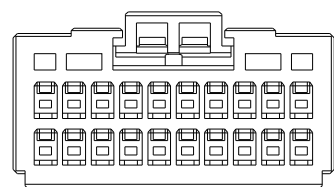
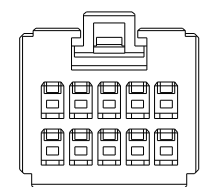
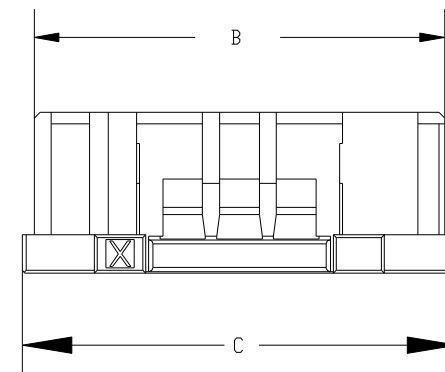
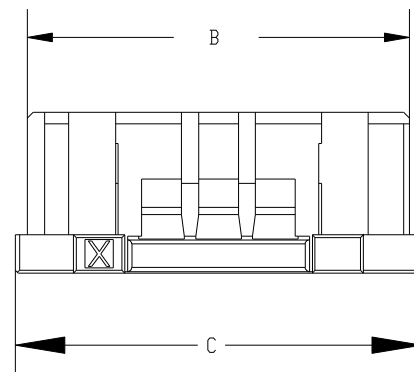
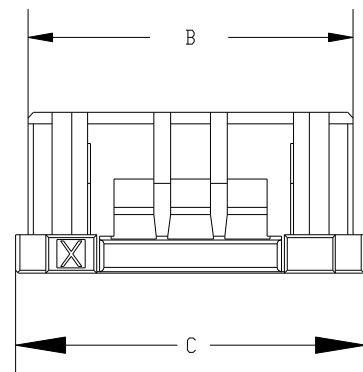
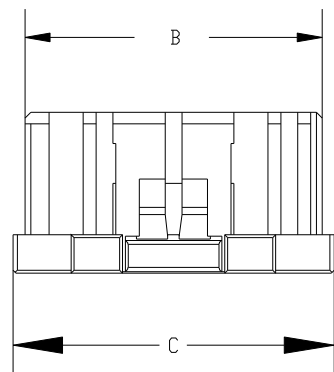
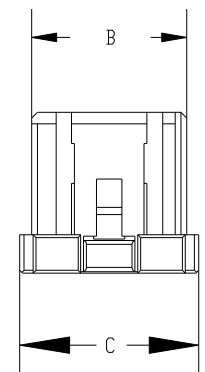
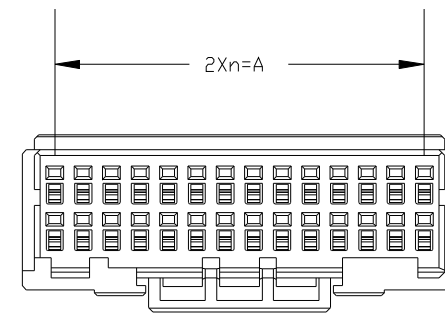
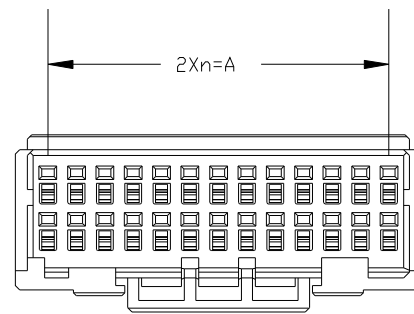
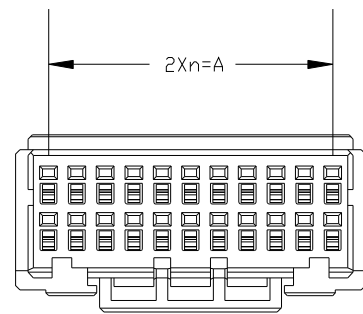
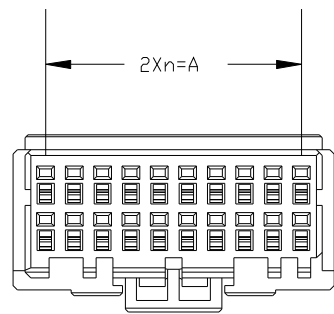
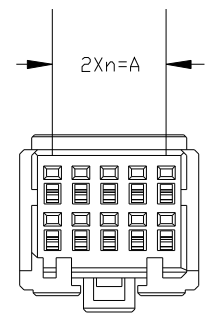

KF 7020-0510-2.0P

KF 7020-1020-2.0P

KF 7020-1122-2.0P

KF 7020-1326-2.0P

KF 7020-1428-2.0P

设计	李国常	序号	数量	材料	颜色
校对				PA-GF	黑色
审定	林振华				
客户型号					
第三角画法	标记	更改前数值	标记	更改前数值	更改日期
产品材料/颜色	产品名称	胶壳		产品型号	KF 7020-XXXX-2.0P
深圳市康利通电子科技有限公司	阶段标记	B		图纸编号	
	共1页 第1页 比例	1:1	单位	mm	设计日期 2019-01-03

版次: 1.0

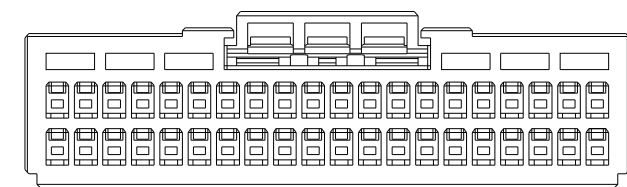
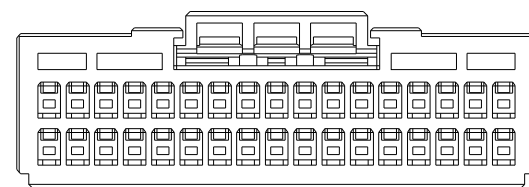
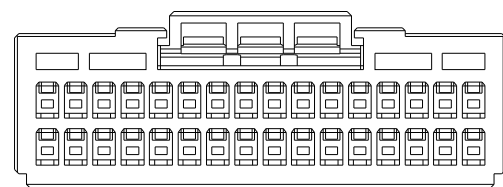
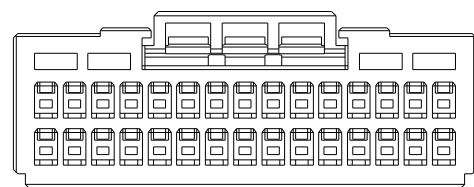
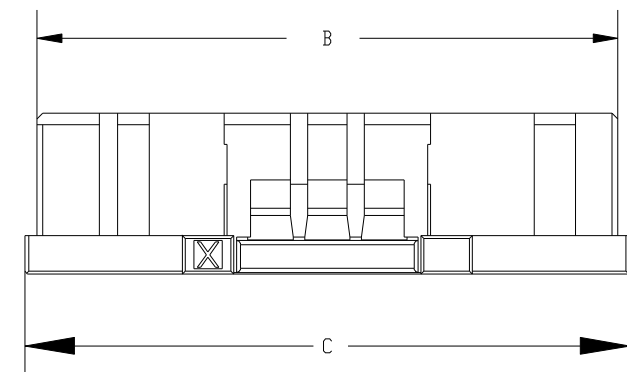
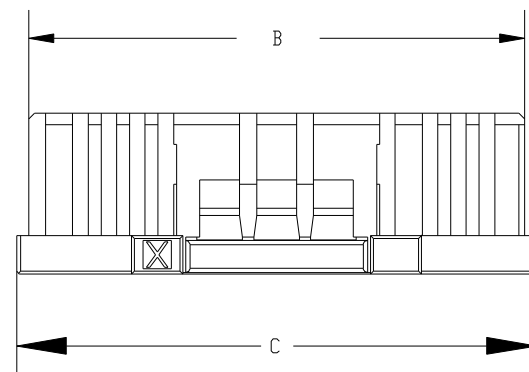
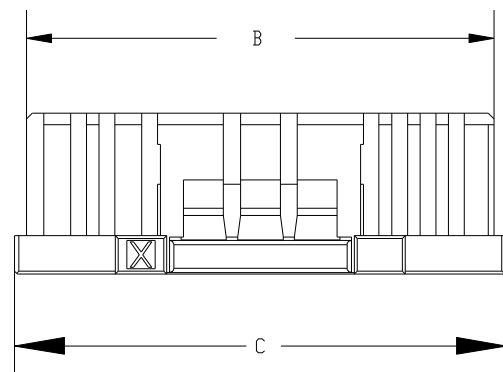
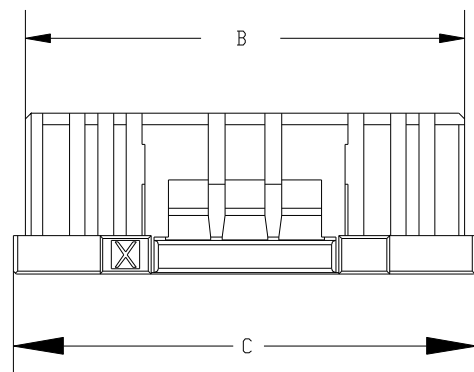
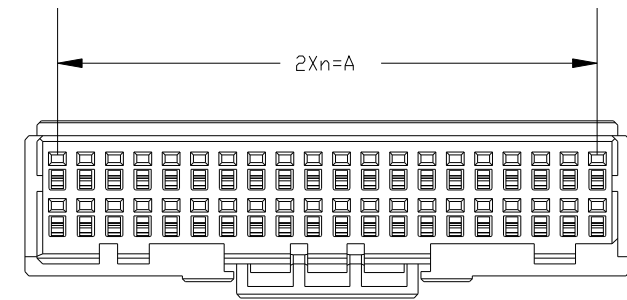
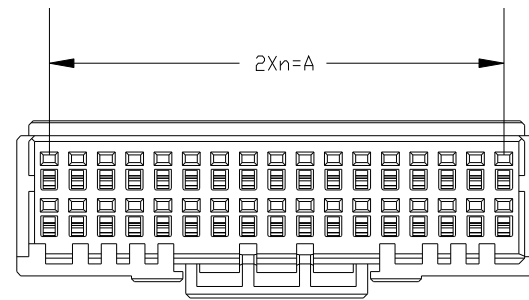
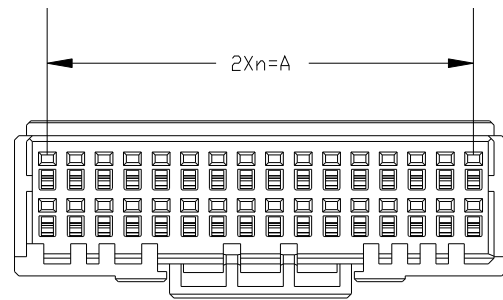
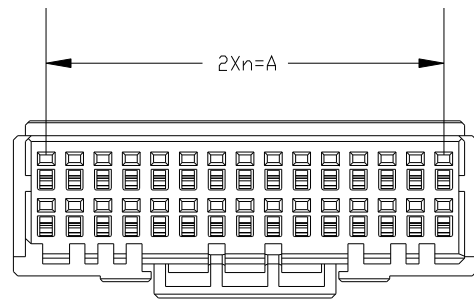

KF 7020-1530-2.0P

KF 7020-1632-2.0P

KF 7020-1734-2.0P

KF 7020-2040-2.0P

设计	李国常	序号	数量	材料	颜色
校对				PA-GF	黑色
审定	林振华				
客户型号					
第三角画法		标记	更改前数值	标记	更改前数值
产品材料/颜色		产品名称	胶壳	产品型号	KF 7020-XXXX-2.0P
深圳市康利通电子科技有限公司	阶段标记		B	图纸编号	
	共1页 第1页 比例	1:1	单位	mm	设计日期
					2019-01-03